User's Guide

Publication Number 01132-97005
May 2009

For Safety and Regulatory information, see the pages at the back of this book.

© Copyright Agilent Technologies 2009
All Rights Reserved.

1132A 5 GHz InfiniiMax Differential and Single-ended Probes

In This Book

This book provides user and service documentation for the Agilent Technologies 1132A differential and single-ended probes. It is divided into two chapters.

Chapter 1 provides an overview of the recommended configurations and capacitance values of the probe; shows you how to use the convenience accessories with the probe; and provides the frequency, impedance, and time response for the recommended configurations of the probe.

Chapter 2 provides service and performance verification information for the probe.

At the back of the book you will find Safety information and Regulatory information.

Contents

1 Differential and Single-ended Probe Configurations

Introduction 1-2

Convenience Accessories 1-3

Using the Velcro strips and dots 1-3

Using the ergonomic handle 1-4

Slew Rate Requirements for Different Technologies 1-6

Understanding and Using Offset With InfiniiMax Active Probes 1-9

Case 1 - A single-ended probe head probing a single-ended signal: 1-9

Case 2 - A differential probe head probing a single-ended signal: 1-9

Case 3 - A differential probe head probing a differential signal: 1-9

Using the N2880A InfiniiMax In-Line Attenuator Kit 1-10

Configuring Attenuators on an Infiniium Series Oscilloscope 1-11

Calibrating/Configuring Attenuators on an InfiniiVision Series Oscilloscope 1-12

N2881A InfiniiMax DC Blocking Caps 1-13

Recommended Configurations Overview 1-14

1 Solder-in Differential Probe Head (full bandwidth resistors) 1-14

2 Socketed Differential Probe Head (full bandwidth resistors) 1-15

3 Differential Browser Probe Head 1-16

4 Solder-in Single-ended Probe Head (full bandwidth resistors) 1-17

5 Single-ended Browser Probe Head 1-18

6 Solder-in Differential Probe Head (medium bandwidth resistor) 1-19

7 Solder-in Single-ended Probe Head (medium bandwidth resistor) 1-20

8 Socketed Differential Probe Head with damped wire accessory 1-21

Recommended configurations at a glance 1-22

Detailed Information for Recommended Configurations 1-23

1 Solder-in Differential Probe Head (Full Bandwidth) 1-24

2 Socketed Differential Probe Head (Full Bandwidth) 1-27

3 Differential Browser 1-30

4 Solder-in Single-ended Probe Head (Full Bandwidth) 1-33

5 Single-ended Browser 1-36

6 Solder-in Differential Probe Head (Medium Bandwidth) 1-39

7 Solder-in Single-ended Probe Head (Medium Bandwidth) 1-42

8 Socketed Differential Probe Head with Damped Wire Accessory 1-45

2 Service

Service Strategy for the 1132A Probe 2-3

To return the probe to Agilent Technologies for service 2-4

Troubleshooting 2-5

Failure Symptoms 2-6

Probe Calibration Fails 2-6

Incorrect Pulse Response (flatness) 2-6

Incorrect Input Resistance 2-6

Incorrect Offset 2-6

Calibration Testing Procedures 2-7

To Test Bandwidth 2-8

Using the 8720ES VNA successfully 2-8

Initial Setup 2-8

Calibrating a Reference Plane 2-9

Contents

Measuring Vin Response	2-14
Measuring Vout Response	2-15
Displaying Vin/Vout Response on 8720ES VNA Screen	2-15
Performance Test Record	2-17
Replaceable Parts and Accessories	2-18

Differential and Single-ended Probe Configurations

Introduction

The 1132A InfiniiMax Active Probing System allows probing of differential and single-ended signals to a bandwidth of over 5 GHz with excellent common mode rejection. Additionally, Agilent's resistor-at-the-tip technology (introduced in the 115X probe family) provides high fidelity and low input loading. This system uses interchangeable probe heads to optimize the performance and usability of three connection types: hand browsing, solder-in and plug-on socket. Differential probe heads offer easy measurement of differential signals and greatly improve the measurement of single-ended signals. Single-ended probe heads offer extremely small size for probing single-ended signals in confined spaces with some reduction in performance. The probe heads provided for this system are:

- Differential Hand-held Browser (or for probe holders) allows temporary connection to points in a system. This probe head provides the highest performance hand-held browser for measuring differential and single-ended signals while maintaining excellent usability due to the adjustable tip spacing and full z-axis compliance.
- Differential Solder-In Probe Head allows a soldered connection into a system for a reliable, hands-free connection. This probe head provides full bandwidth performance with the lowest input loading for probing differential and single-ended signals. At the tip it uses a miniature axial lead resistor with 8 mil diameter leads which allows connection to very small, fine pitch targets.
- Differential Socket-Tip Probe Head provides sockets that accept 20 mil diameter pins with 100 mil spacing. The intended application for this probe head is to insert two of the supplied 20 mil diameter lead resistors into the sockets and then solder the resistors into the target system. This allows a removable, hands-free connection that provides full bandwidth with a minor increase in capacitance over the solder-in probe head for probing differential and single-ended signals. Additionally, 3.6 cm resistor tip wire accessories are provided for high fidelity lower bandwidth probing of signals with very wide spacing. It is recommended that a 25 mil diameter plated through hole on the board for mounting the lead resistors.
- Single-ended Hand-held Browser (or for probe holders) allows temporary connection to points in a system for single-ended signals only. This browser has lower bandwidth than the differential browser, but is very small which allows probing in tight areas.
- Single-ended Solder-In Probe Head allows a soldered connection for a reliable hands-free connection to single-ended signals only. This probe head has lower bandwidth than the differential solder-in probe head, but is extremely small which allows probing in tight areas or probing several signals located close together.

The E2669A Differential Connectivity Kit includes the differential browser, solder-in, and socket-tip probe heads. Also included is an Ergonomic Handle for the browser along with other accessories. This allows full bandwidth probing of differential and single-ended signals.

The E2668A Single-ended Connectivity Kit includes the single-ended browser and solder-in probe heads as well as the differential socket-tip probe head. A single-ended socket-tip probe head was not developed since it did not offer a significant size advantage. Also included is an Ergonomic Handle for the browser along with other accessories.

In order to take the guesswork out of how to connect your probe, the Detailed Information for Recommended Configurations section shows the various probe heads along with their performance information. This allows you to quickly make the measurements you need with confidence in the performance and signal fidelity. Using the recommended connection configurations is your key to making accurate oscilloscope measurements with known performance levels.

Convenience Accessories

Using the Velcro strips and dots

The Velcro strips and dots can be used to secure the probe amp to a circuit board removing the weight of the probe from the circuit connection. This is done by using the following steps.

- 1 Wrap the Velcro strip around the probe amp body.
- 2 Attach a Velcro dot to the circuit board.
- 3 Attach the Velcro strip to the Velcro dot.

Figure 1-1

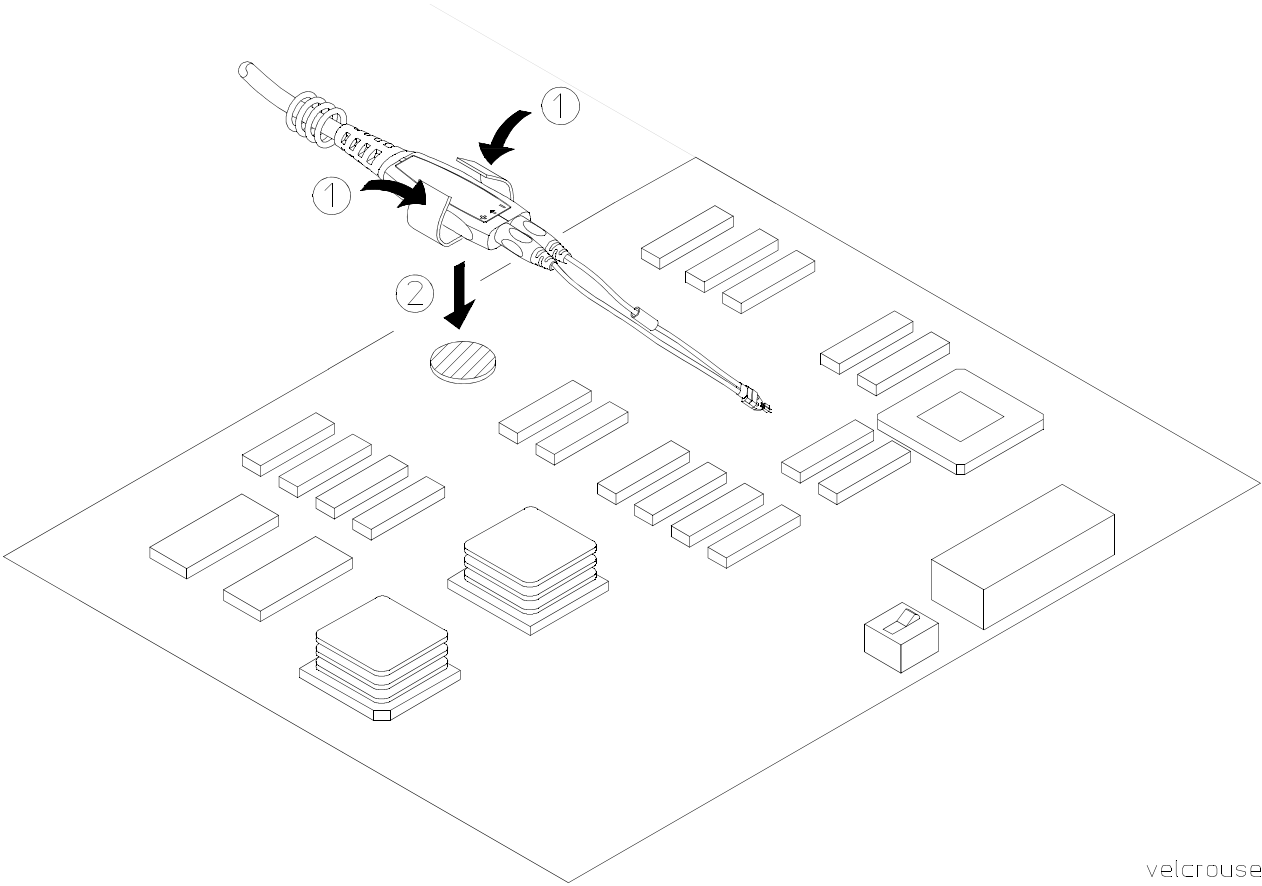

Using the Velcro dots and strips.

Differential and Single-ended Probe Configurations Convenience Accessories

Using the ergonomic handle

Because of their small size, it can be difficult to hold the single-ended or the differential browsers for extended periods of time. The ergonomic handle can be used to more comfortably hold the browser. The following pictures show how to mount the browser in the ergonomic handle.

Figure 1-2

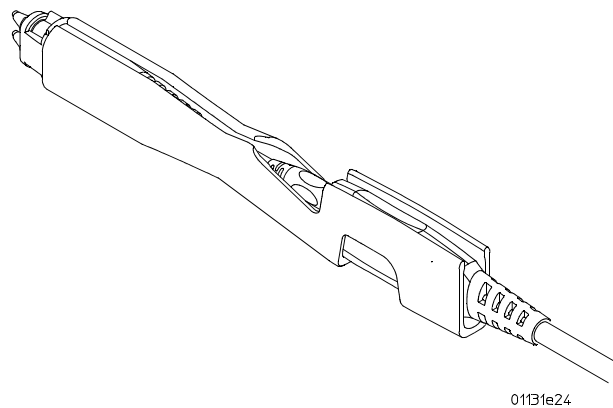
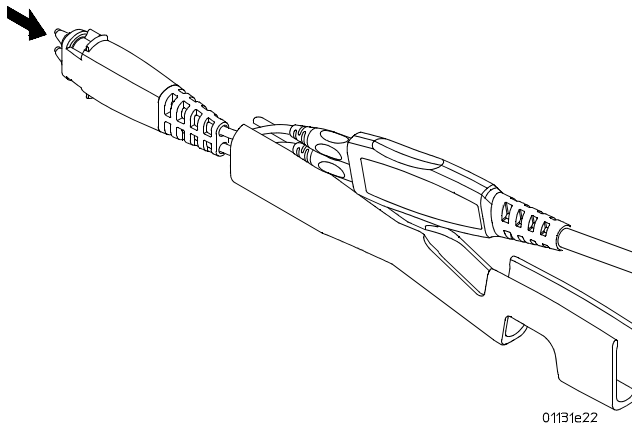
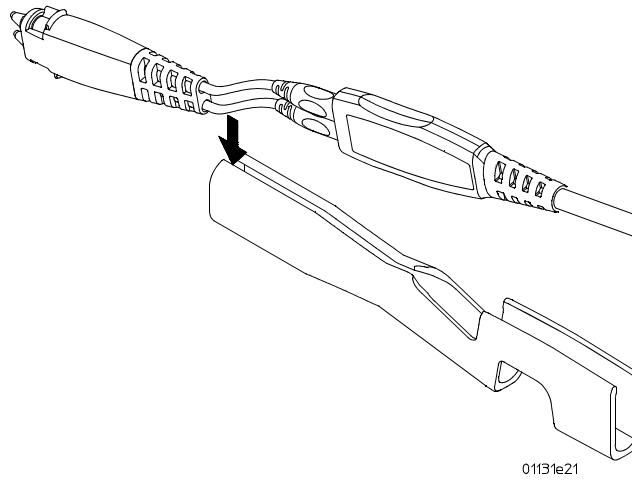

The following pictures show how to remove the browser from the ergonomic handle.

Figure 1-3

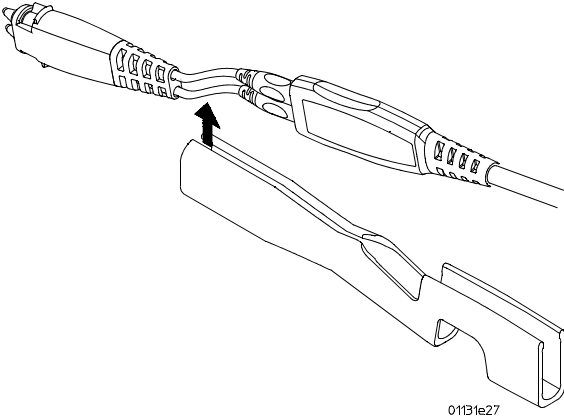
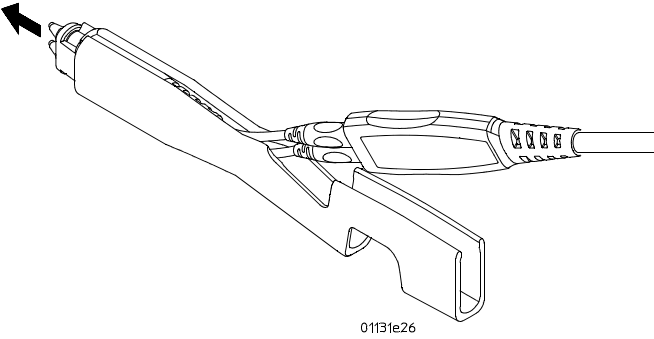
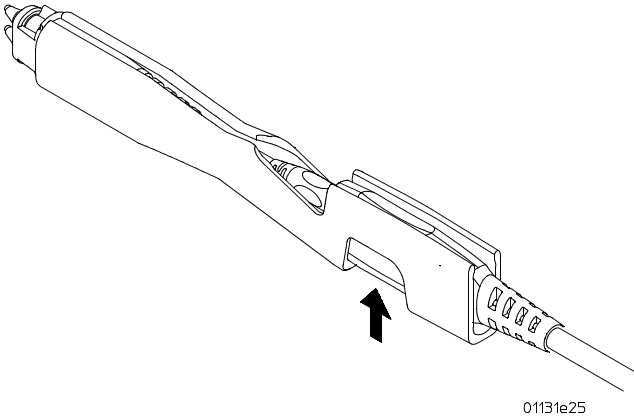

**Differential and Single-ended Probe Configurations
Slew Rate Requirements for Different Technologies**

Slew Rate Requirements for Different Technologies

The following table shows the slew rates for several different technologies. The maximum allowed input slew rate is 18 V/ns for single-ended signals and 30 V/ns for differential signals. Table 1-1 shows that the maximum required slew rate for the different technologies is much less than that of the probe.

Table 1-1

Slew Rate Requirements

Name of Technology	Differential Signal	Max Single-Ended Slew Rate ¹ (V/ns)	Max Differential Slew Rate ² (V/ns)	Driver Min Edge Rate (20%-80% ps)	Max Transmitter Level (Diff V)
PCI Express (3GIO)	YES	9.6	19.2	50	1.6
RapidIO Serial 3.125Gb	YES	8.0	16.0	60	1.6
10GbE XAUI (4x3.125Gb)	YES	8.0	16.0	60	1.6
1394b	YES	8.0	16.0	60	1.6
Fibre Channel 2125	YES	8.0	16.0	75	1
Gigabit Ethernet 1000Base-CX	YES	7.8	15.5	85	2.2
RapidIO 8/16 2Gb	YES	7.2	14.4	50	1.2
Infiniband 2.5Gb	YES	4.8	9.6	100	1.6
HyperTransport 1.6Gb	YES	4.0	8.0	113	1.5
SATA (1.5Gb)	YES	1.3	2.7	134	0.6
USB 2.0	YES	0.9	1.8	375	1.1
DDR 200/266/333	NO	7.2	n/a	300	3.6
PCI	NO	4.3	n/a	500	3.6
AGP-8X	NO	3.1	n/a	137	0.7

1 The probe specification is 18 V/ns

2 The probe specification is 30 V/ns

Figure 1-4

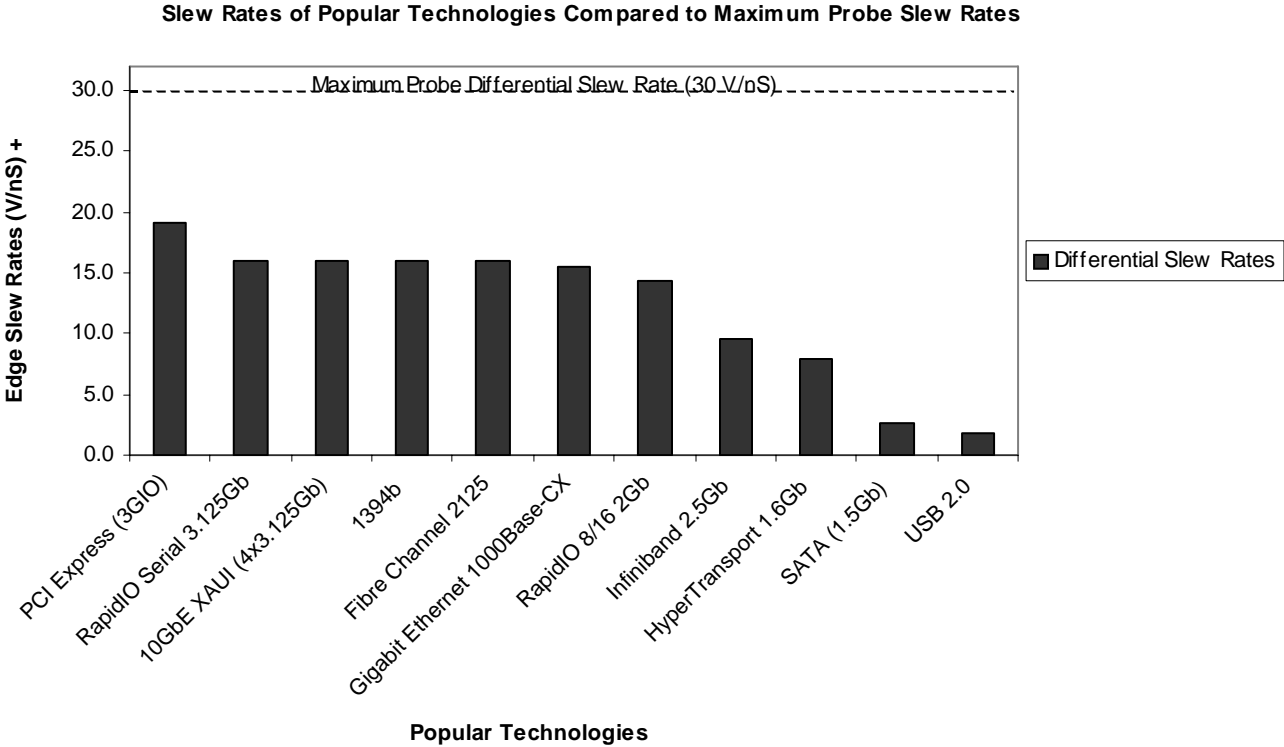

+ $\frac{\text{Maximum Edge Amplitude} \times 0.6}{\text{Minimum 20\% to 80\% Rise Time}}$

Differential and Single-ended Probe Configurations Slew Rate Requirements for Different Technologies

Figure 1-5

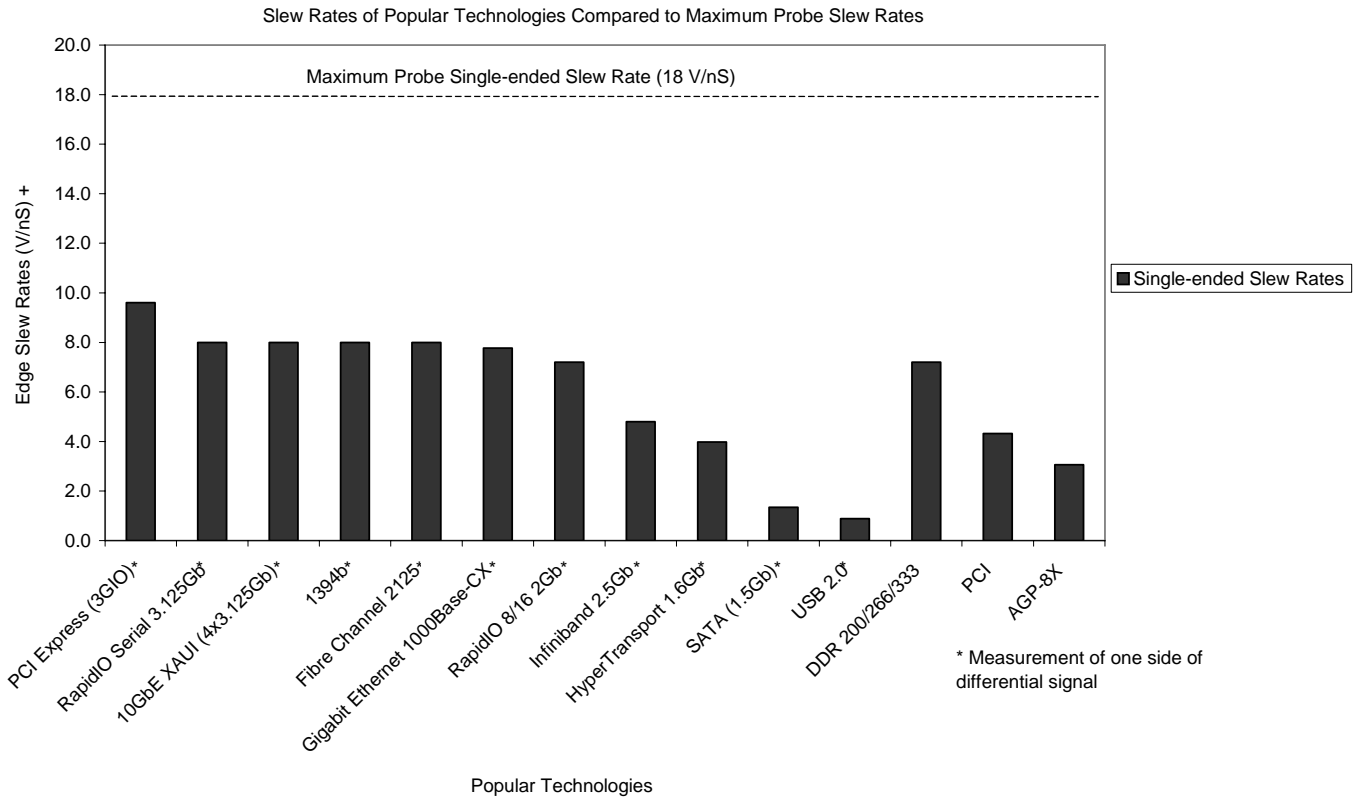

+
$$\frac{\text{Maximum Edge Amplitude} \times 0.6}{\text{Minimum 20\% to 80\% Rise Time}}$$

Understanding and Using Offset With InfiniiMax Active Probes

It is important to understand how the 1132A probe behaves with respect to offset when different probe head / signal combinations are used.

The purpose of offset in active probes or oscilloscope front ends is to allow the subtraction of most or all of the dc component of the input signal so the signal can better utilize the dynamic range of the input. When using an InfiniiMax probe with an Infiniium oscilloscope, you can select the case (see the three cases described below) that applies for your measurement by selecting the "Probes" button under the channel setup menu. This allows you to select which type of probe head is being used and, if it is a differential probe head, allows you to select whether you are probing a differential or single-ended signal. With these inputs, the oscilloscope will use the proper type of offset for your measurement case. The specifics for each case are discussed below.

As an important side note, whenever adjusting the offset for a particular probe head, make sure to have a triggered signal.

Case 1 - A single-ended probe head probing a single-ended signal:

For this case, the offset control on the oscilloscope controls the probe offset and the channel offset is set to zero. This allows the offset voltage to be subtracted from the input signal before the signal gets to the differential amplifier. Since this subtraction is done before any active circuits, the offset range is large (+/- 12 V for the 1132A amplifier and 25-k Ω probe heads). Note that the minus probe tip is not present when using a single-ended probe head which means nothing is plugged into the "-" input of the probe amp. This is normal and causes no problems.

Case 2 - A differential probe head probing a single-ended signal:

For this case, the offset control on the oscilloscope controls the probe offset and the channel offset is set to zero. This allows the offset voltage to be subtracted from the input signal before the signal gets to the differential amplifier. Since this subtraction is done before any active circuits, the offset range is large (+/- 12 V for the 1132A amplifier and 25-k Ω probe heads). A differential probe can make higher bandwidth and more accurate measurements on single-ended signals than a single-ended probe and this method of applying offset to only the plus side of a differential probe means there is no sacrificing of offset range.

Case 3 - A differential probe head probing a differential signal:

For this case, the offset control on the oscilloscope controls the oscilloscope channel offset. The probe offset is not used and set to zero. Since the plus and minus sides of differential signals have the same dc component, it will be subtracted out and the output of the probe will by definition be centered around ground.

The channel offset allows the waveform seen on screen to be moved as desired. The allowable dc component in the plus and minus signals is determined by the common mode range of the probe which for the 1132A probe amp and 25-k Ω probe heads is +/- 6.75 V.

Using the N2880A InfiniiMax In-Line Attenuator Kit

The dynamic ranges of the InfiniiMax 1130A Series and the InfiniiMax 1168A/1169A Series are $5 V_{p-p}$ and $3.3 V_{p-p}$ respectively. If you need to measure larger signals, the architecture of the InfiniiMax probes allows you to add the N2880A InfiniiMax In-Line Attenuators between the probe head and the probe amplifier to increase the dynamic range (see picture below). Additionally, these attenuators enable you to increase the offset range of the probe (see the table below). When using the N2880A In-Line Attenuators, the bandwidth and rise time of your probing system is not affected. There is, however, a trade-off in noise (see table below) and in the accuracy of DC offset relative to the input.



The maximum input voltage of the InfiniiMax probe heads is $\pm 30 V_{dc}$ (depending on the frequencies of your signal, the maximum allowed slew rate (see table below) may require that the maximum input voltage magnitude be less than 30 V), so they should not be used to measure signals that exceed this range. This places a practical limit of 20 dB on the attenuators used with the InfiniiMax probing system. Larger attenuation ratios will only degrade the noise performance and gain of the system.

The N2880A kit consists of 3 pairs of attenuators (6 dB, 12 dB, and 20 dB). These attenuators come as matched pairs and should only be used with each other. If you look on each attenuator, you will see a serial number. The pair of matching attenuators in each set will have the same four digit numeric prefix and will differ by the last letter (one attenuator in the matched pair will be labeled A and the other will be labeled B).

All InfiniiMax probe heads and amplifiers are compatible with the N2880A In-Line Attenuators. However, due to the N5380A dual-SMA probe head's maximum input voltage specification of 2.28 VRMS, the N5380A is not suitable for measuring signals large enough to require an added attenuator.

InfiniiMax Probe Amplifier	Added Attenuator	Dynamic Range	Offset Range	Typical Noise Referred to	Maximum Allowed Input Slew Rate** (se = single-ended) (diff = differential)	Nominal DC Attenuation of Probe System
1130A Series	None	5 V _{p-p}	$\pm 12 V$	3 mV RMS	se: 18 V/ns, diff: 30 V/ns	10:1
1130A Series	6 dB (2:1)	10 V _{p-p}	$\pm 24 V$	7.8 mV RMS	se: 36 V/ns, diff: 60 V/ns	20:1
1130A Series	12 dB (4:1)	20 V _{p-p}	$\pm 30 V^*$	16.7 mV RMS	se: 72 V/ns, diff: 120 V/ns	40:1
1130A Series	20 dB (10:1)	50 V _{p-p}	$\pm 30 V^*$	41.7 mV RMS	se: 180 V/ns, diff: 300 V/ns	100:1
1168A/1169A	None	3.3 V _{p-p}	$\pm 16 V$	2.2 mV RMS	se: 25 V/ns, diff: 40 V/ns	3.45:1
1168A/1169A	6 dB (2:1)	6.6 V _{p-p}	$\pm 30 V^*$	6.3 mV RMS	se: 50 V/ns, diff: 80 V/ns	6.9:1
1168A/1169A	12 dB (4:1)	13.2 V _{p-p}	$\pm 30 V^*$	13.2 mV RMS	se: 100 V/ns, diff: 160 V/ns	13.8:1
1168A/1169A	20 dB (10:1)	33.3 V _{p-p}	$\pm 30 V^*$	33.4 mV RMS	se: 250 V/ns, diff: 400 V/ns	34.5:1

*The actual range of DC voltage for these attenuators is greater than $\pm 30 V$, but the usable range of DC voltage at the probe input is limited to $\pm 30 V_{dc}$. Also, depending on the frequencies of your signal, the maximum allowed slew rate may require that the maximum input voltage magnitude be less than 30 V.

Note: The values shown above do not apply to the N5380A dual-SMA probe head. Due to the maximum input voltage specification of 2.28 VRMS for the N5380A, it is not suitable for measuring signals large enough to require an added attenuator.

** These slew rate do not apply when the N5380A and E2695A SMA probe heads are used with the InfiniiMax amplifiers.

Below are the frequency response plots for four setups: the probe without any attenuators, the probe with the 6 dB attenuators, the probe with the 12 dB attenuators, and the probe with the 20 dB attenuators.

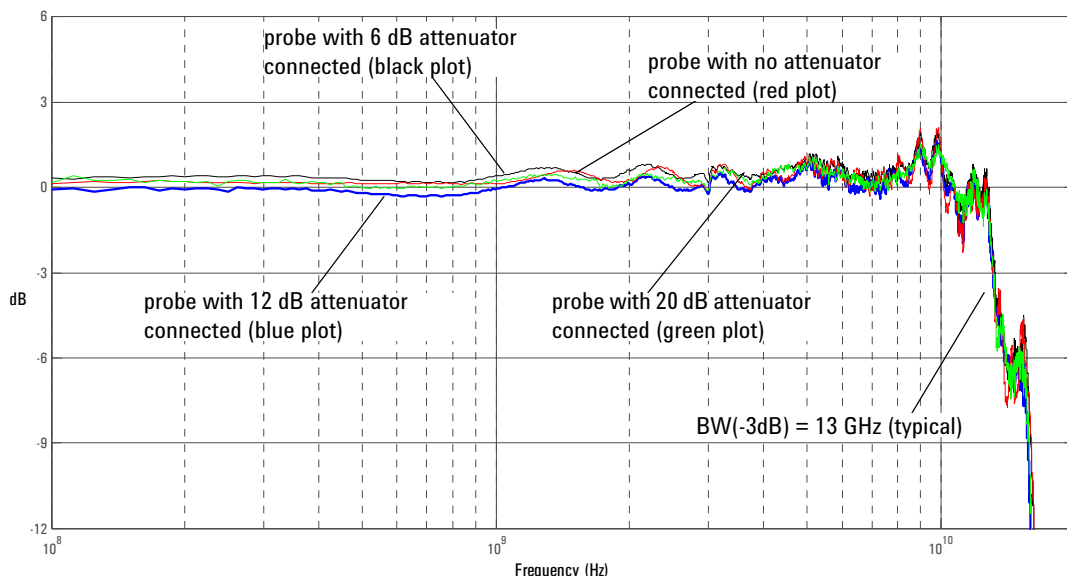

Graph of $\text{dB}(V_{\text{out}}/V_{\text{in}}) + 10.8 \text{ dB}$ of probe (red plot), $\text{dB}(V_{\text{out}}/V_{\text{in}}) + 6 \text{ dB}$ attenuator + 10.8 dB of probe (black plot), $\text{dB}(V_{\text{out}}/V_{\text{in}}) + 12 \text{ dB}$ attenuator + 10.8 dB of probe (blue plot), and $\text{dB}(V_{\text{out}}/V_{\text{in}}) + 20 \text{ dB}$ attenuator + 10.8 dB of probe (green plot)

The software in the Infiniium and InfiniiVision oscilloscopes will detect a probe when it is connected and by default will assume that no additional attenuators are installed. If you want to scale readings and settings on the oscilloscope so they are correct with the attenuators installed, refer to the procedures below for your specific oscilloscope series.

Calibrating Attenuators on an Infiniium Series Oscilloscope

You cannot calibrate your InfiniiMax probes with the attenuators attached. Please calibrate the InfiniiMax probes as you normally would (with no attenuators), configure the attenuators as discussed in the next section, and begin probing.

Configuring Attenuators on an Infiniium Series Oscilloscope

First, plug your InfiniiMax probe amplifier / probe head into one of the oscilloscope channels with the attenuators connected. Then enter the **Probe Setup** dialog box (can be reached via **Setup > Probes** on the oscilloscope menu). Press the **Configure Probing System** button. A pop-up window will appear where you can select **External Scaling**. Click the **Decibel** radio button under the *External Scaling* section and then set the **Gain** field to either -6 dB, -12 dB, or -20 dB depending on the attenuator you are using (be sure to include the negative sign). Finally, you will need to manually set the **Offset** field in this dialog box to zero out the signal.

Differential and Single-ended Probe Configurations Using the N2880A InfiniiMax In-Line Attenuator Kit

Calibrating/Configuring Your Probe with Attenuators on an InfiniiVision Series Oscilloscope

NOTE: The following instructions only apply if you have InfiniiVision software release 5.25 or newer installed on your oscilloscope.

First, plug your InfiniiMax probe amplifier / probe head into one of the oscilloscope channels with the attenuators attached. Press the Channel on/off key to turn the channel on (if the channel is off). Press the Probe softkey in the Channel menu. A series of probe related softkeys will appear. The second softkey from the left is for specifying your probe head. Repeatedly press this softkey until the probe head selection matches the attenuator you are using. The choices are:

- 10:1 single-ended browser
- 10:1 differential browser
- 10:1 (+6 dB Atten) single-ended browser
- 10:1 (+6 dB Atten) differential browser
- 10:1 (+12 dB Atten) single-ended browser
- 10:1 (+12 dB Atten) differential browser
- 10:1 (+20 dB Atten) single-ended browser
- 10:1 (+20 dB Atten) differential browser

Once the probe head configuration has been selected, you can press the Calibration key in the same probe menu and follow the on-screen instructions to calibrate the probe/attenuator setup.

N2881A InfiniiMax DC Blocking Caps

The architecture of the InfiniiMax probing system allows you to place the N2881A DC Blocking Caps in between the probe amplifier and the probe head (as shown in the picture below). These N2881A InfiniiMax DC Blocking Caps block out the DC component of the input signal (up to 30 V_{dc}).



The N2881A InfiniiMax DC Blocking Caps can be used with the N2880A In-Line Attenuators. The order of the two products in the probing system (*i.e.* which one is closest to the probe amplifier) does not matter.

Below is the frequency response plot of the N2881A DC Blocking Caps (no probe included).

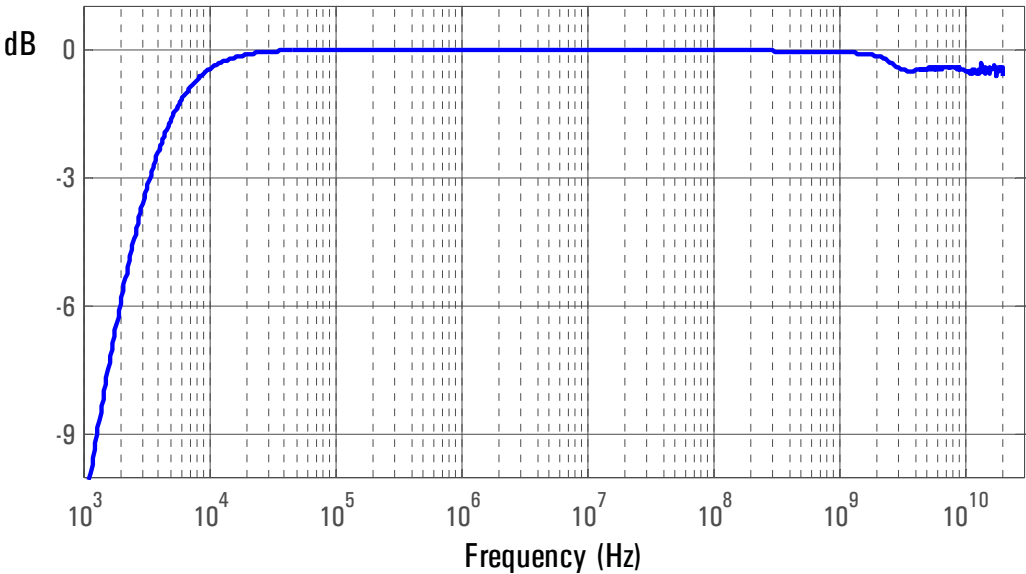

Graph of DC Blocking Cap insertion loss (S2,1) versus frequency (DC Blocking Cap only)

Recommended Configurations Overview

The recommended configurations are designed to give the best probe performance for different probing situations. The probe configurations are shown in the order of the best performance to the least performance.

1 Solder-in Differential Probe Head (full bandwidth resistors)

This configuration has a bandwidth of greater than 5 GHz (see the graphs starting on page 1-24). The configuration consists of the following parts:

- E2677A — Solder-in Differential Probe Head
- 01131-81510 — 91 Ω mini-axial lead resistors (2 each)

The 01131-81510 resistor has been trimmed and formed as per template 01131-94311.

Figure 1-6

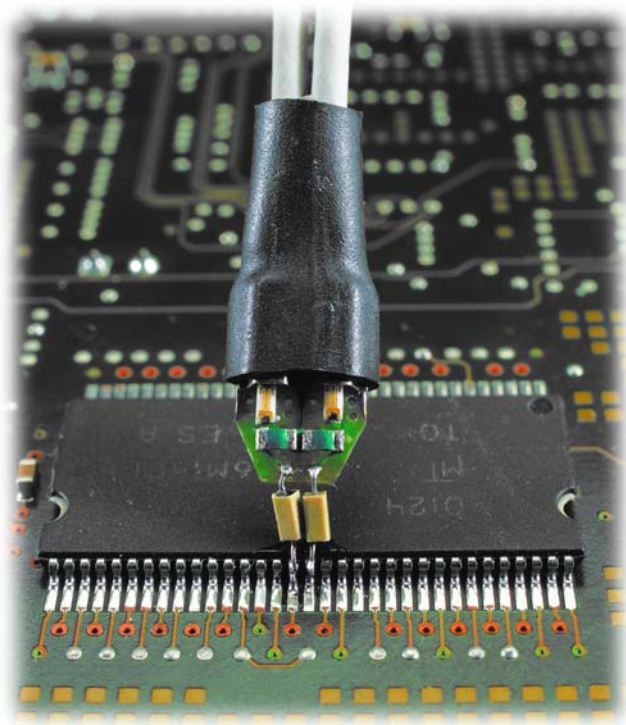

2 Socketed Differential Probe Head (full bandwidth resistors)

This configuration has a bandwidth of greater than 5 GHz (see the graphs starting on page 1-27).
This configuration consists of the following parts:

- E2678A — Socketed Differential Probe Head
- 01130-81506 — 82 Ω axial lead resistors (2 each)

The 01130-81506 resistor has been trimmed and formed as per template 01131-94308.

Figure 1-7

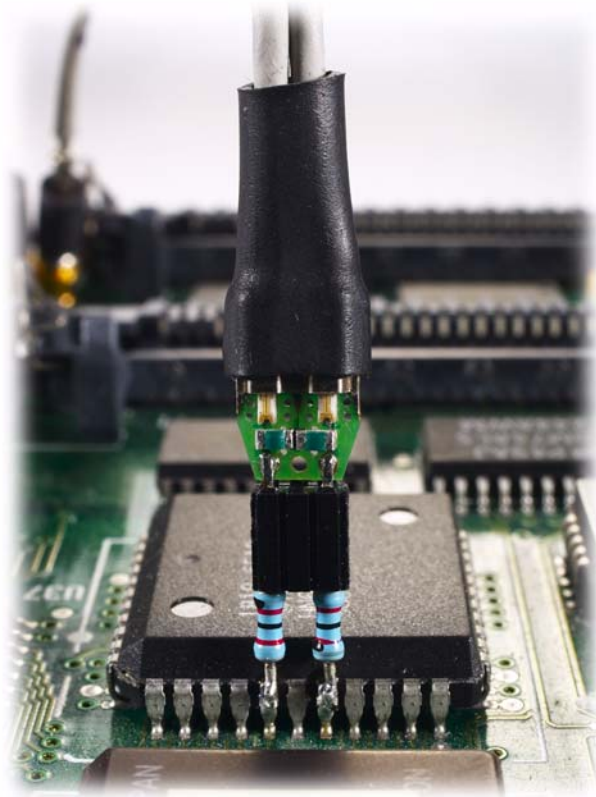

Differential and Single-ended Probe Configurations Recommended Configurations Overview

3 Differential Browser Probe Head

This configuration has a bandwidth greater than 5 GHz (see the graphs starting on page 1-30). This configuration consists of the following parts:

- E2675A — Differential Browser Probe Head
- 01131-62102 — 91 Ω resistor probe tips (2 each)

Figure 1-8

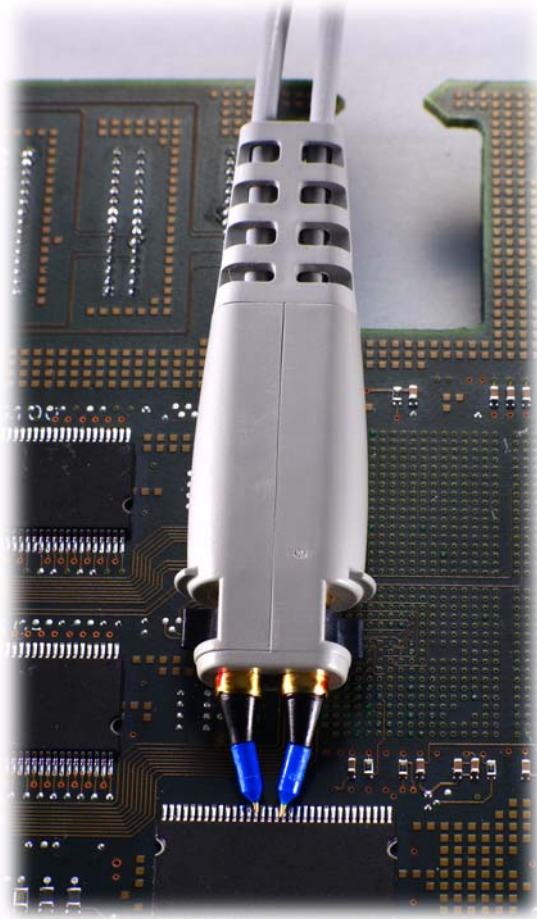

4 Solder-in Single-ended Probe Head (full bandwidth resistors)

This configuration has a bandwidth greater than 5 GHz (see the graphs starting on page 1-33). This configuration consists of the following parts:

- E2679A — Solder-in Single-ended Probe Head
- 01131-81510 — 91 Ω mini-axial lead resistor
- 01131-81504 — 0 Ω mini-axial lead resistor

The 01131-81510 and 01131-81504 resistors have been trimmed and formed as per template 01131-94311.

Figure 1-9

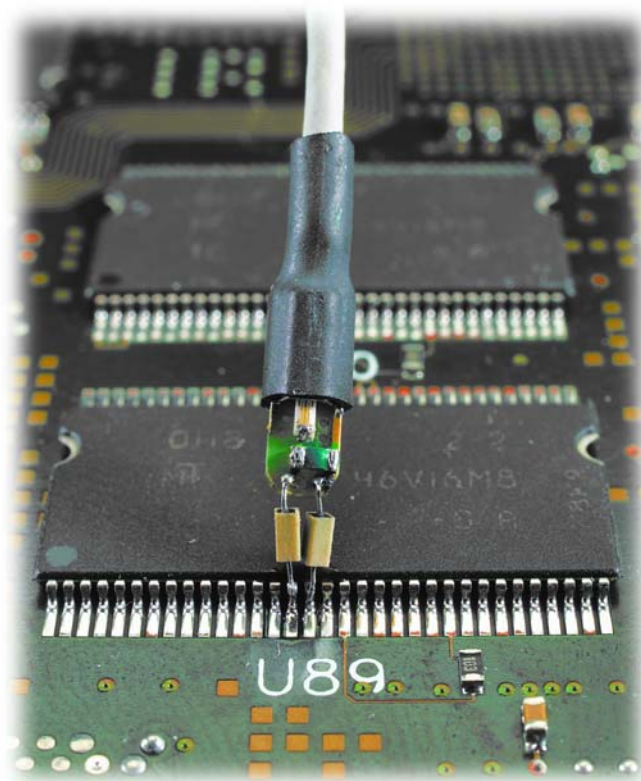

5 Single-ended Browser Probe Head

This configuration has a bandwidth greater than 5 GHz (see the graphs starting on page 1-36). This configuration consists of the following parts:

- E2676A — Single-ended Browser Probe Head
- 01131-62102 — 91 Ω resistor probe tip
- 01130-60005 — Ground collar assembly

Figure 1-10

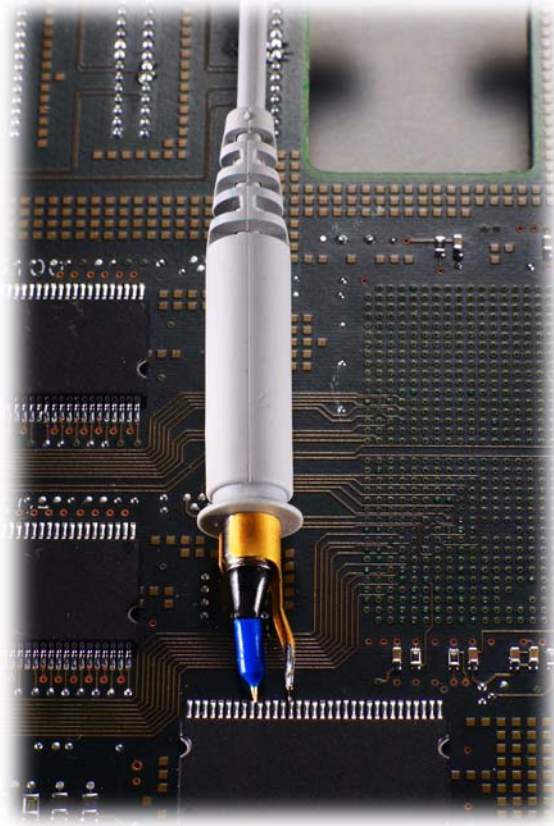

6 Solder-in Differential Probe Head (medium bandwidth resistor)

This configuration has a bandwidth approximately equal to 2.9 GHz (see the graphs starting on page 1-39). This configuration consists of the following parts:

- E2677A — Solder-in Differential Probe Head
- 01131-81506 — 150 Ω mini-axial lead resistors (2 each)

The 01131-81506 resistor has been trimmed and formed as per template 01131-94308.

Figure 1-11



Differential and Single-ended Probe Configurations Recommended Configurations Overview

7 Solder-in Single-ended Probe Head (medium bandwidth resistor)

This configuration has a bandwidth approximately equal to 2.2 GHz (see the graphs starting on page 1-42). This configuration consists of the following parts:

- E2679A — Solder-in Single-ended Probe Head
- 01131-81506 — 150 Ω mini-axial lead resistor
- 01131-81504 — 0 Ω mini-axial lead resistor

The 01131-81506 and 01131-81504 resistors have been trimmed and formed as per template 01131-94308.

Figure 1-12

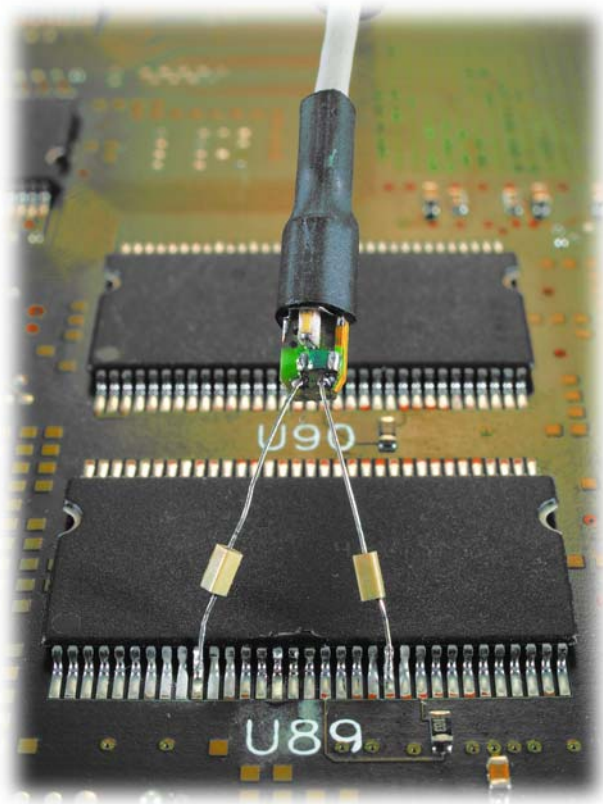

8 Socketed Differential Probe Head with damped wire accessory

This configuration has a bandwidth approximately equal to 1.2 GHz (see the graphs starting on page 1-45). This configuration consists of the following parts:

- E2678A — Socketed Differential Probe Head
- 01130-21302 — 160 Ω damped wire accessory (2 each)

Figure 1-13

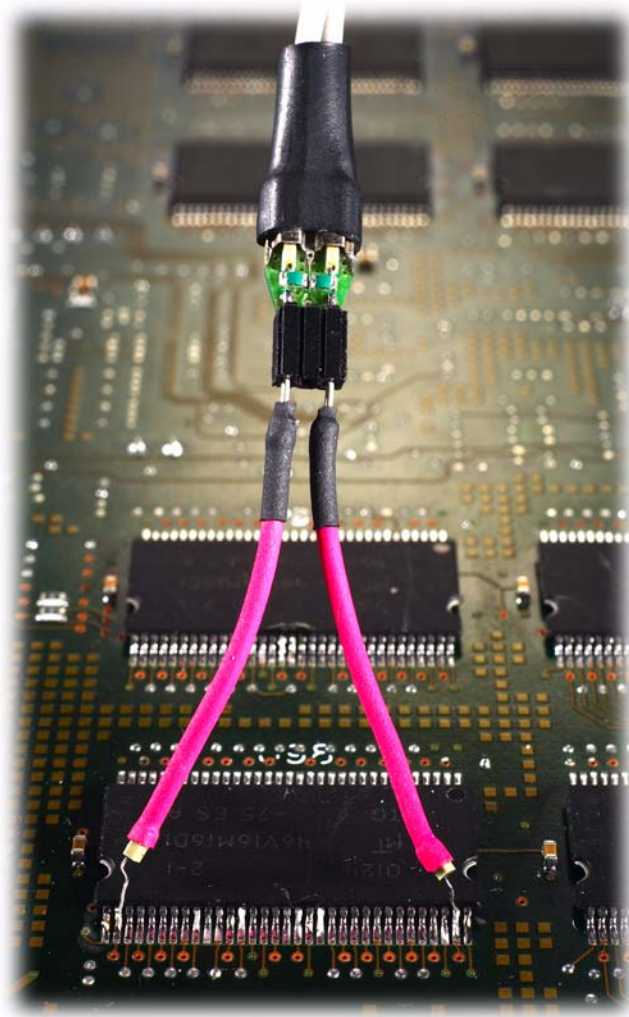

**Differential and Single-ended Probe Configurations
Recommended configurations at a glance**

Recommended configurations at a glance

Table 1-2

Probe Head Configurations	Band width (GHz)	Cdiff ¹ (pF)	Cse ² (pF)	Starting Page of Performance Graphs	Usage
1 Solder-in differential (full bandwidth resistors)	> 5	0.27	0.44	1-24	<ul style="list-style-type: none"> Differential and Single-ended signals Solder-in hands free connection Hard to reach targets Very small fine pitch targets Characterization
2 Socketed differential (full bandwidth resistors)	> 5	0.34	0.56	1-27	<ul style="list-style-type: none"> Differential and Single-ended signals Removable connection using solder-in resistor pins Hard to reach targets
3 Differential browser	> 5	0.32	0.57	1-30	<ul style="list-style-type: none"> Differential and Single-ended signals Hand-held browsing Probe holders General purpose troubleshooting Ergonomic handle available
4 Solder-in single-ended (full bandwidth resistors)	> 5	N/A	0.50	1-33	<ul style="list-style-type: none"> Single-ended signals only Solder-in hands free connection when physical size is critical Hard to reach targets Very small fine pitch targets
5 Single-ended browser	> 5	N/A	0.65	1-36	<ul style="list-style-type: none"> Single-ended signals only Hand or probe holder where physical size is critical General purpose troubleshooting Ergonomic handle available
6 Solder-in differential (medium bandwidth resistors)	~ 2.9	0.33	0.52	1-39	<ul style="list-style-type: none"> Differential and Single-ended signals Solder-in hands free connection Larger span and reach than #1 Very small fine pitch targets
7 Solder-in single-ended (medium bandwidth resistors)	~ 2.2	N/A	0.58	1-42	<ul style="list-style-type: none"> Single-ended signals only Solder-in hands free connection when physical size is critical Larger span and reach than #4 Hard to reach targets Very small fine pitch targets
8 Socketed differential with damped wire accessories	~ 1.2	0.63	0.95	1-45	<ul style="list-style-type: none"> Differential and Single-ended signals For very wide spaced targets Connection to 25 mil square pins when used with supplied sockets

¹ Capacitance seen by differential signals

² Capacitance seen by single-ended signals

Detailed Information for Recommended Configurations

This section contains graphs of the performance characteristics of the 1132A active probe using the different probe heads that come with the E2668A single-ended and E2669A differential connectivity kits.

All rise times shown are measured from the 10 % to the 90 % amplitude levels.

1 Solder-in Differential Probe Head (Full Bandwidth)

Figure 1-1

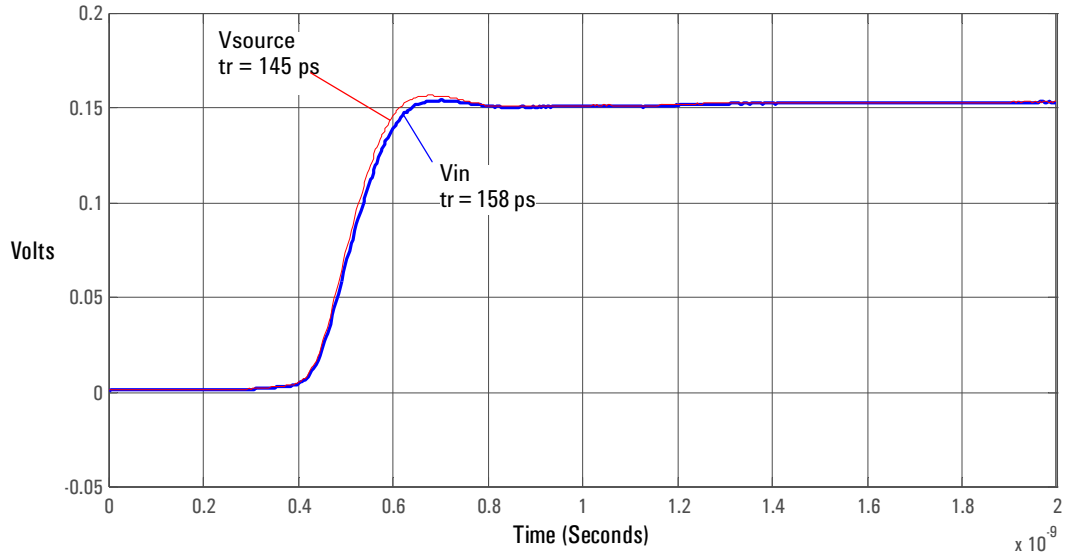

Graph of 25 Ω 100 ps step generator with and without probe connected.

Figure 1-2

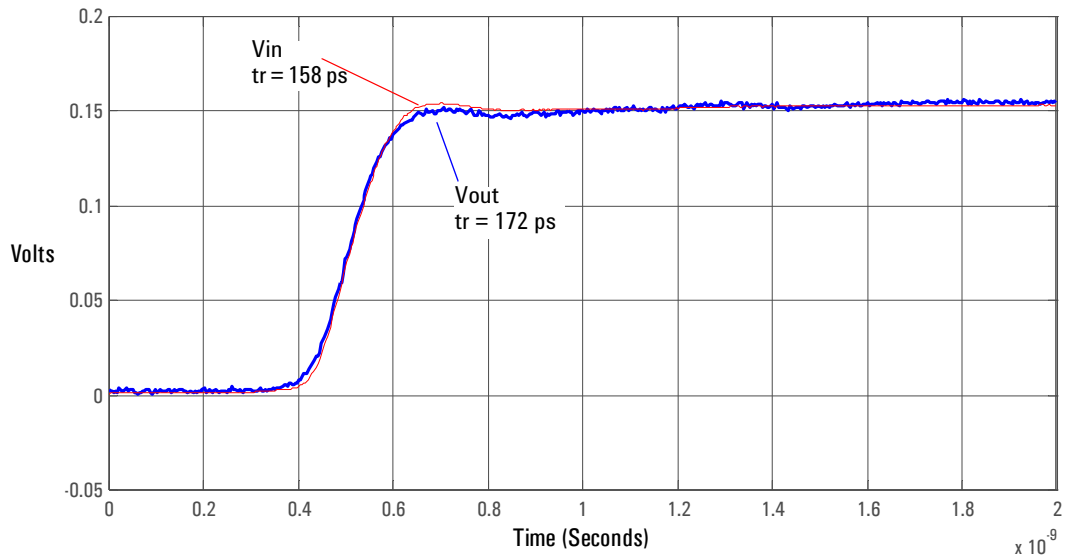

Graph of Vin and Vout of probe with a 25 Ω 100 ps step generator.

Figure 1-3

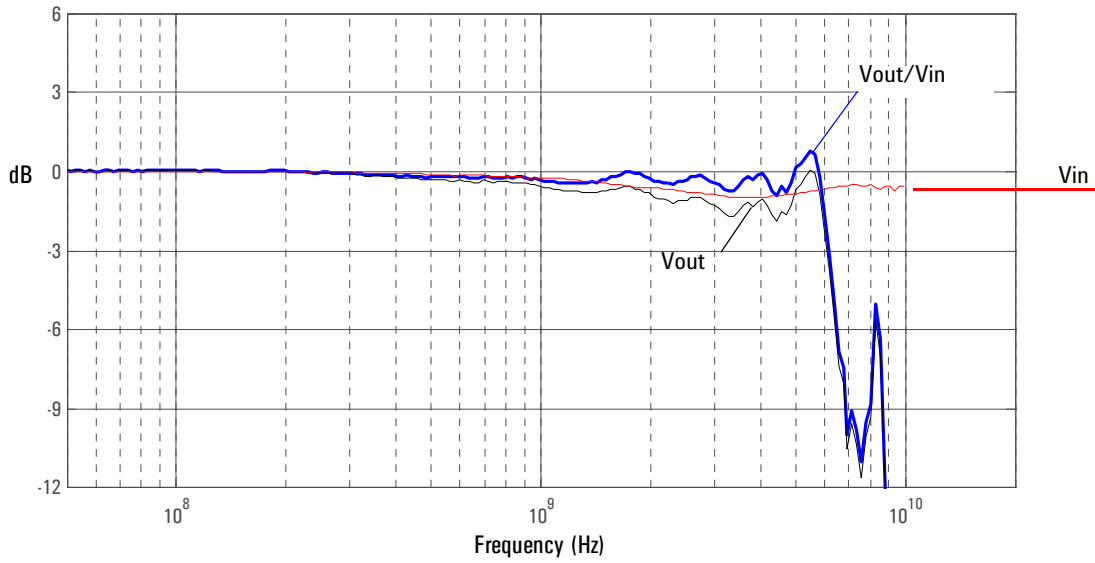

Graph of V_{in} and V_{out} of probe with a $25\ \Omega$ source and V_{out}/V_{in} frequency response.

Figure 1-4

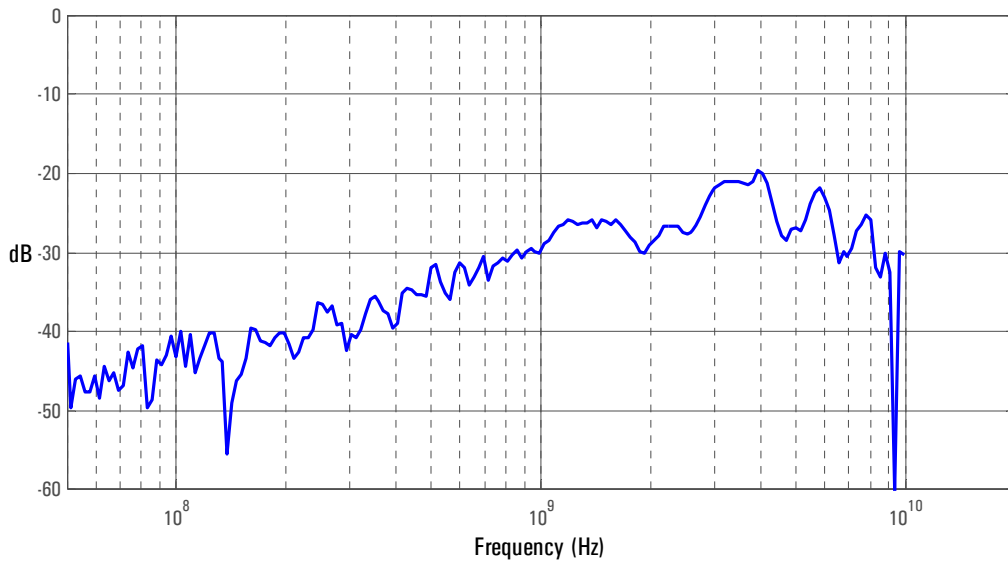

Graph of V_{out}/V_{in} frequency response when inputs driven in common (common mode rejection).

Differential and Single-ended Probe Configurations 1 Solder-in Differential Probe Head (Full Bandwidth)

Figure 1-5

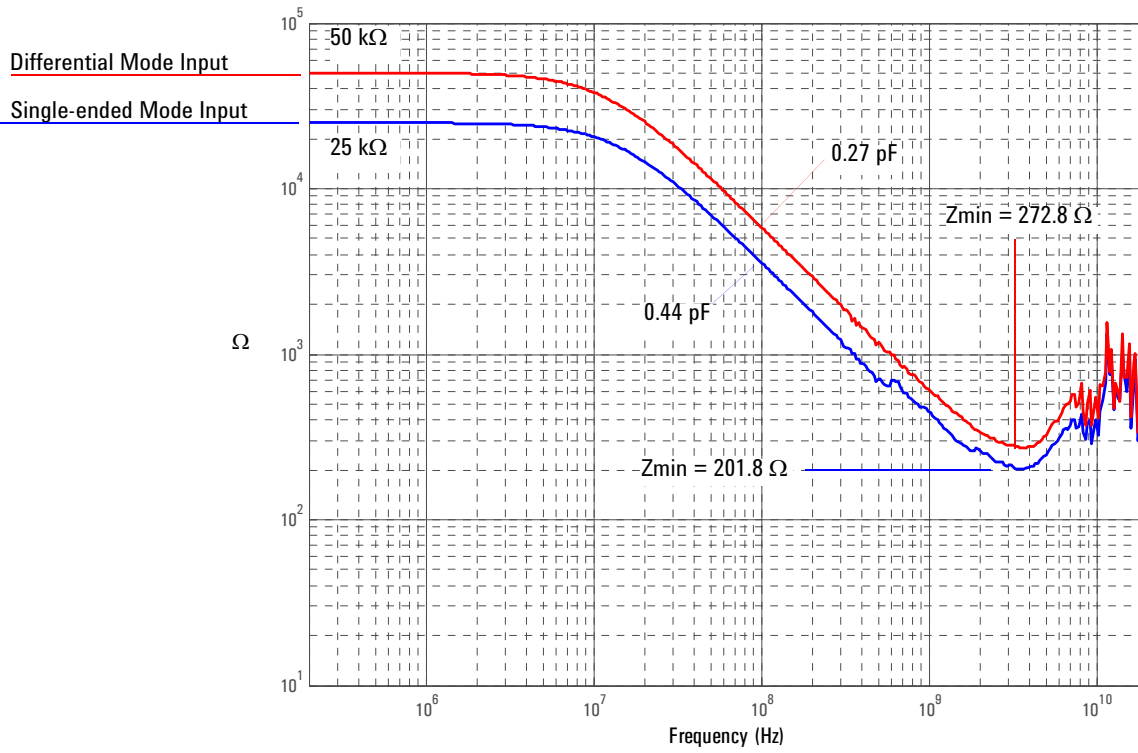

Magnitude plot of probe input impedance versus frequency.

2 Socketed Differential Probe Head (Full Bandwidth)

Figure 1-6

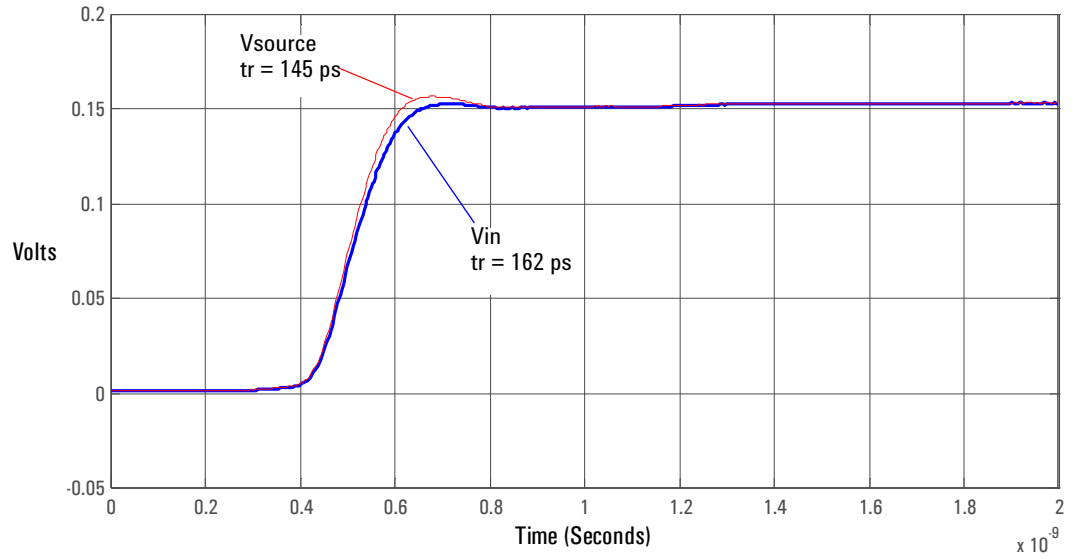

Graph of 25 Ω 100 ps step generator with and without probe connected.

Figure 1-7

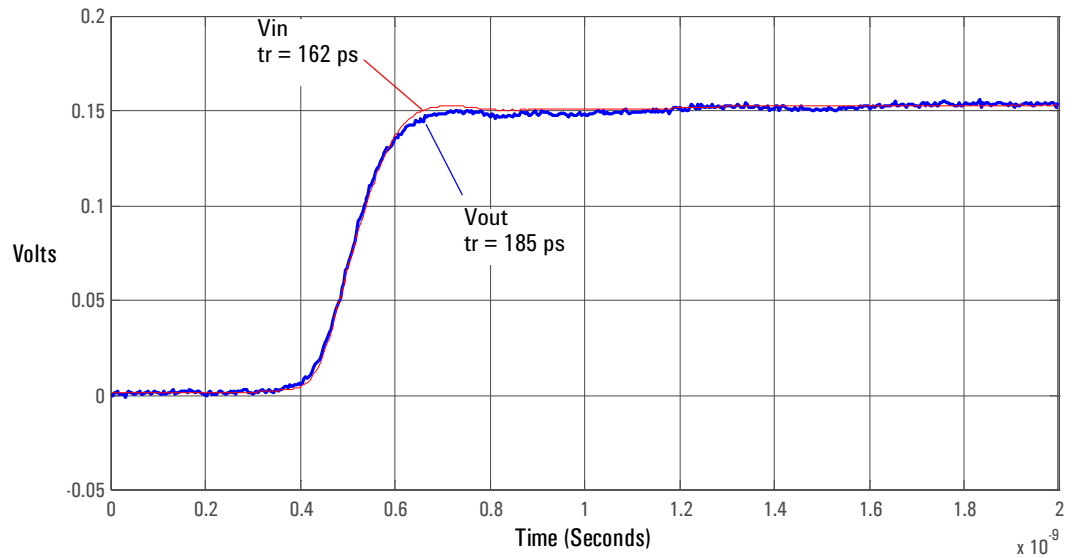

Graph of V_{in} and V_{out} of probe with a 25 Ω 100 ps step generator.

**Differential and Single-ended Probe Configurations
2 Socketed Differential Probe Head (Full Bandwidth)**

Figure 1-8

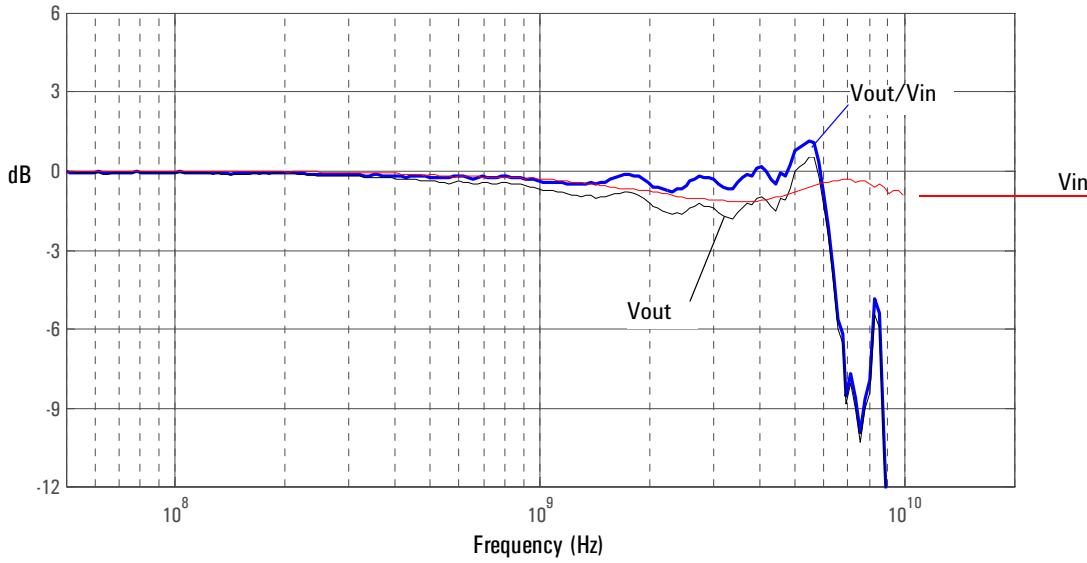

Graph of Vin and Vout of probe with a $25\ \Omega$ source and Vout/Vin frequency response.

Figure 1-9

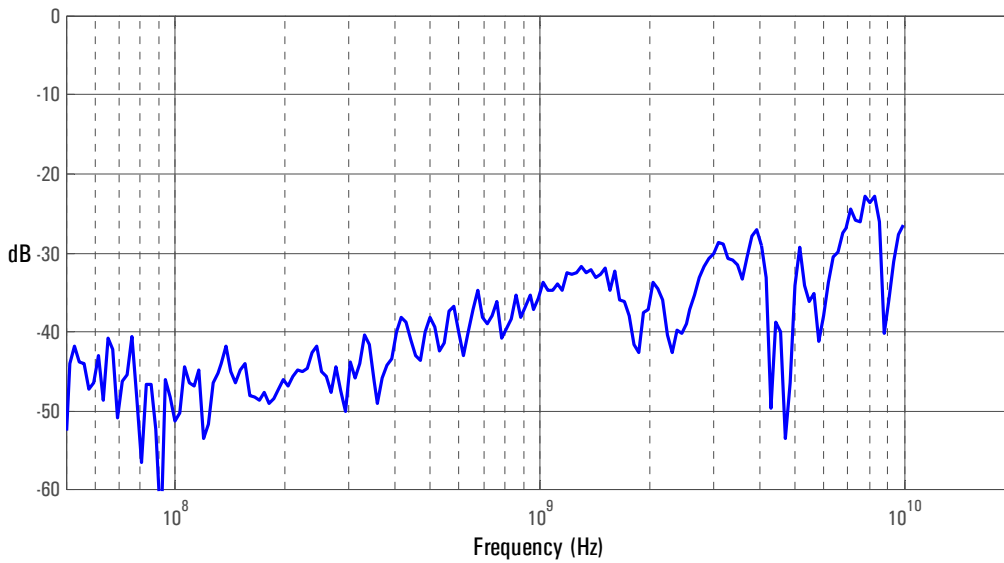

Graph of Vout/Vin frequency response when inputs driven in common (common mode rejection).

Figure 1-10

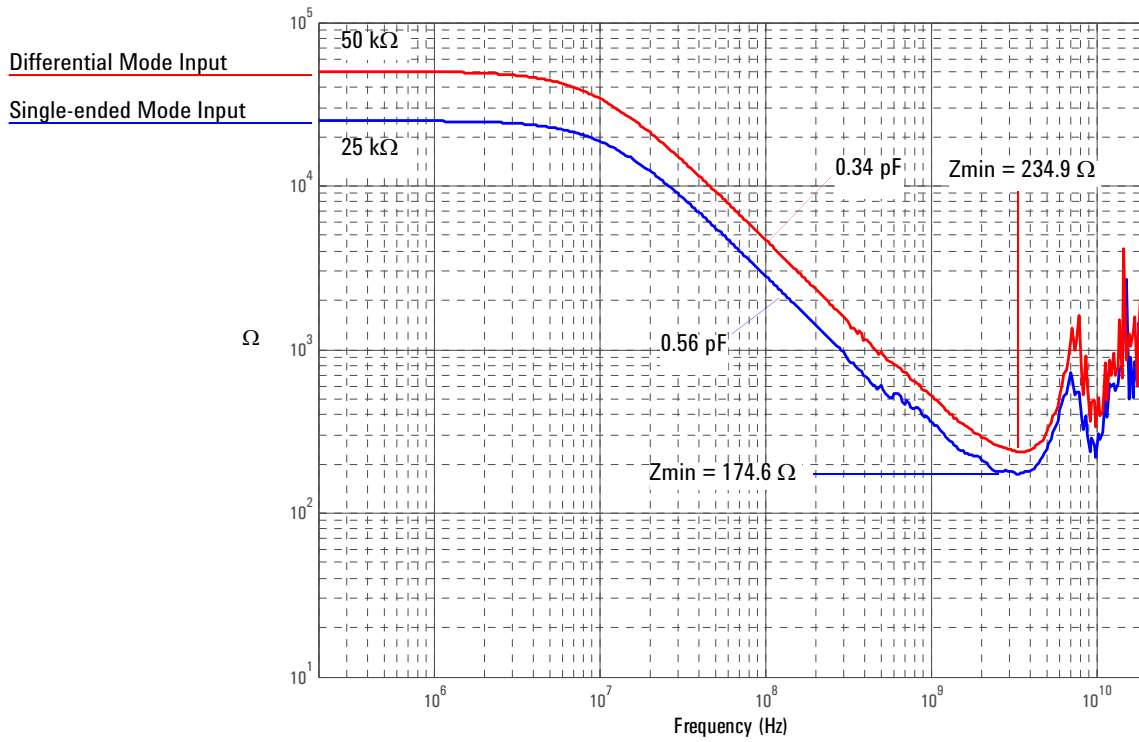

Magnitude plot of probe input impedance versus frequency.

3 Differential Browser

Figure 1-11

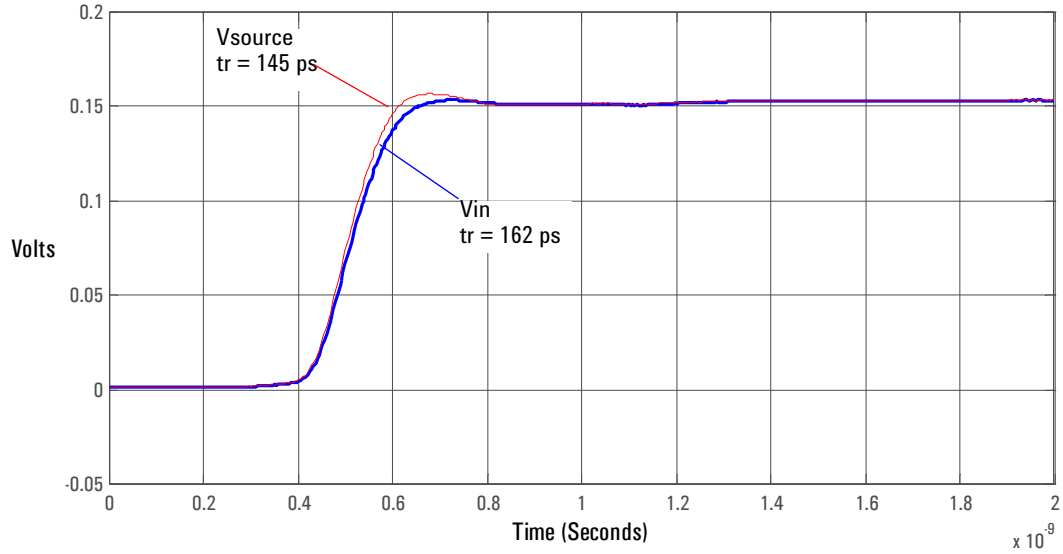

Graph of 25 Ω 100 ps step generator with and without probe connected.

Figure 1-12

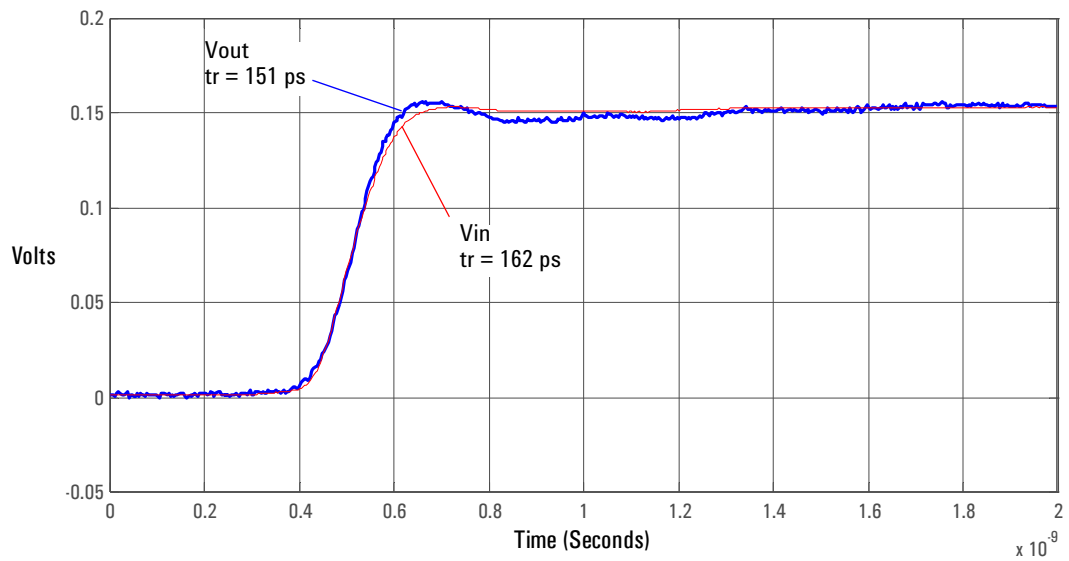

Graph of Vin and Vout of probe with a 25 Ω 100 ps step generator.

Figure 1-13

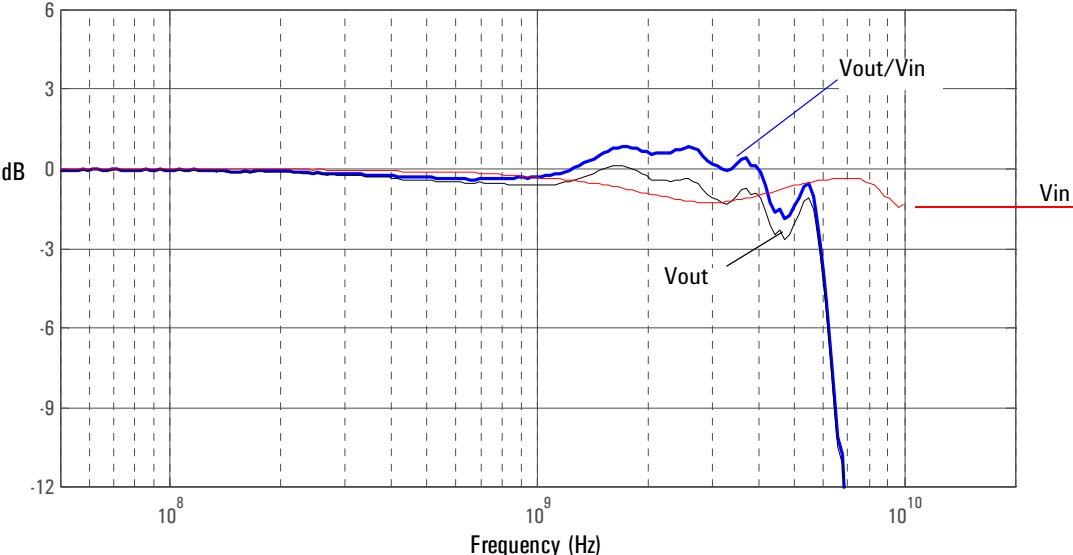

Graph of V_{in} and V_{out} of probe with a $25\ \Omega$ source and V_{out}/V_{in} frequency response.

Figure 1-14

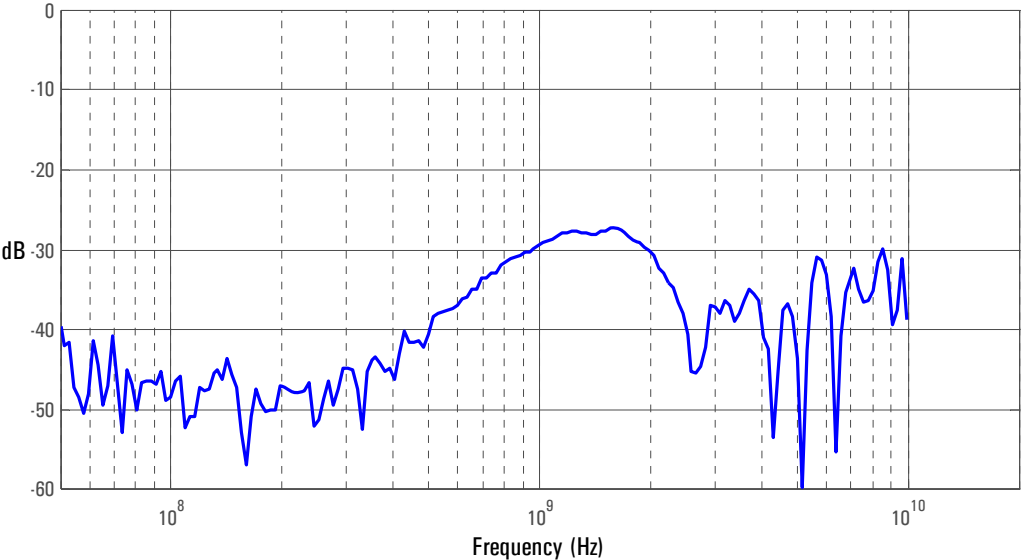

Graph of V_{out}/V_{in} frequency response when inputs driven in common (common mode rejection).

Differential and Single-ended Probe Configurations 3 Differential Browser

Figure 1-15

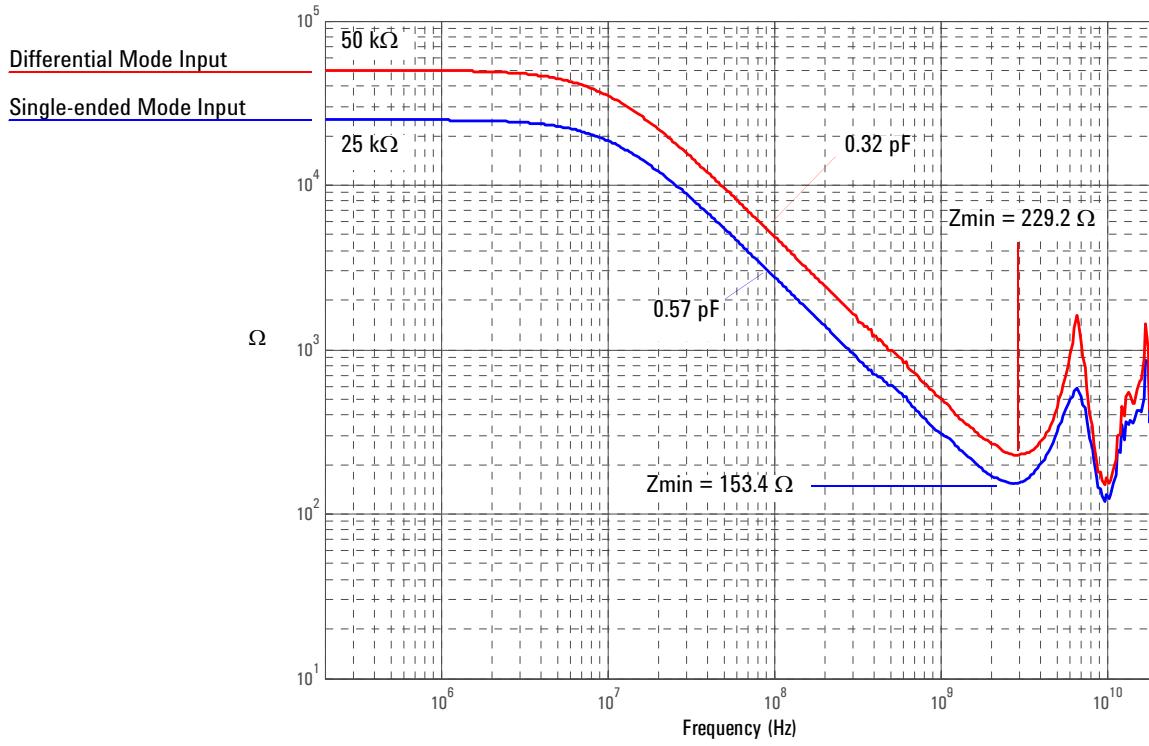

Magnitude plot of probe input impedance versus frequency.

4 Solder-in Single-ended Probe Head (Full Bandwidth)

Figure 1-16

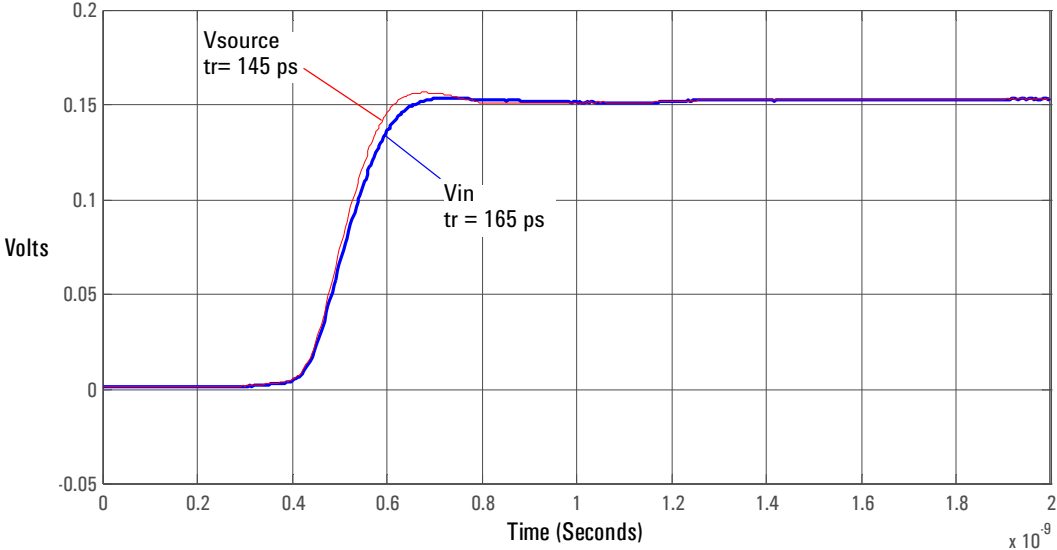

Graph of 25Ω 100 ps step generator with and without probe connected.

Figure 1-17

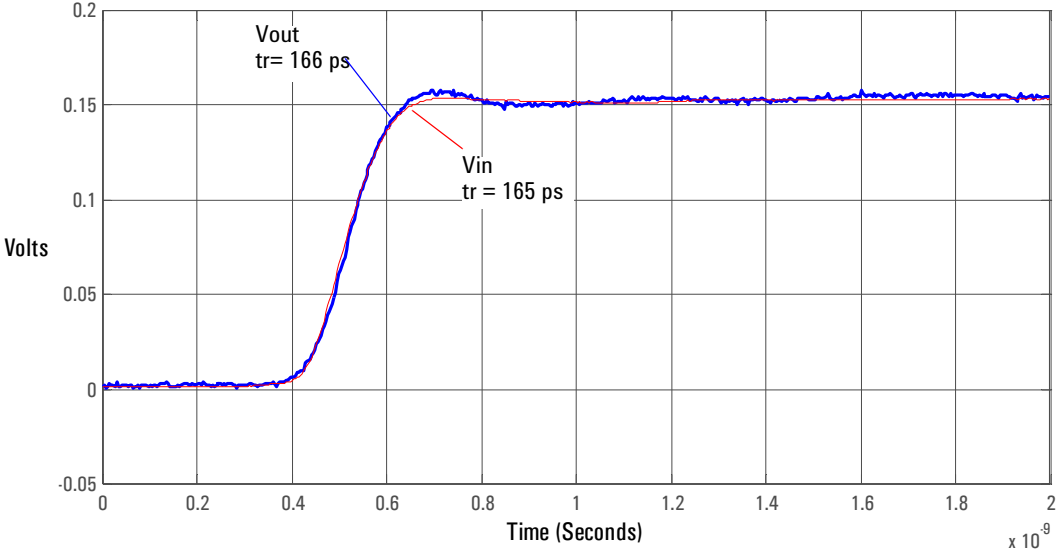

Graph of Vin and Vout of probe with a 25Ω 100 ps step generator.

Differential and Single-ended Probe Configurations 4 Solder-in Single-ended Probe Head (Full Bandwidth)

Figure 1-18

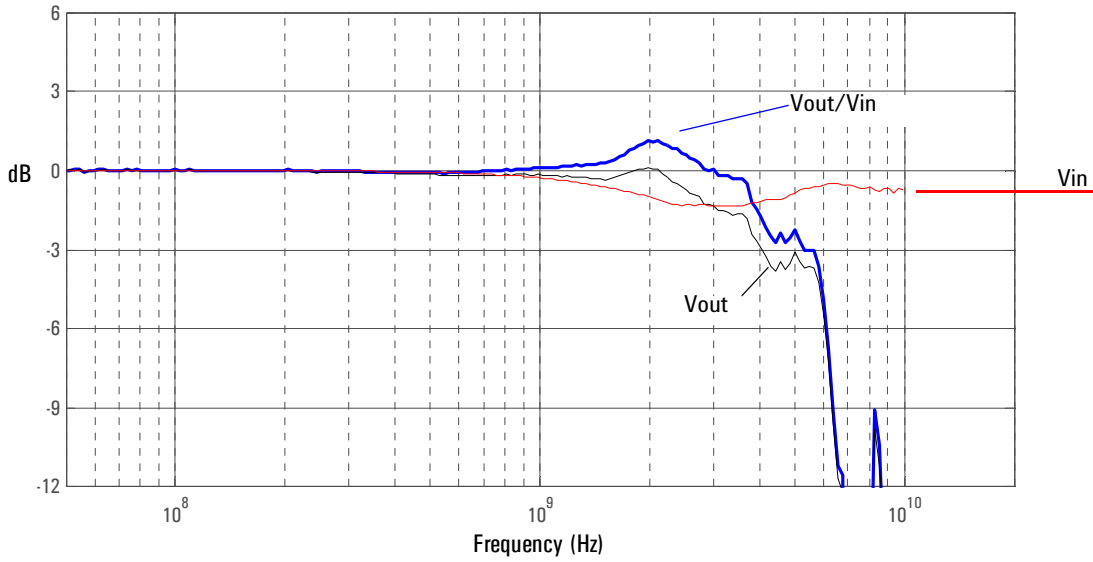

Graph of V_{in} and V_{out} of probe with a $25\ \Omega$ source and V_{out}/V_{in} frequency response.

Figure 1-19

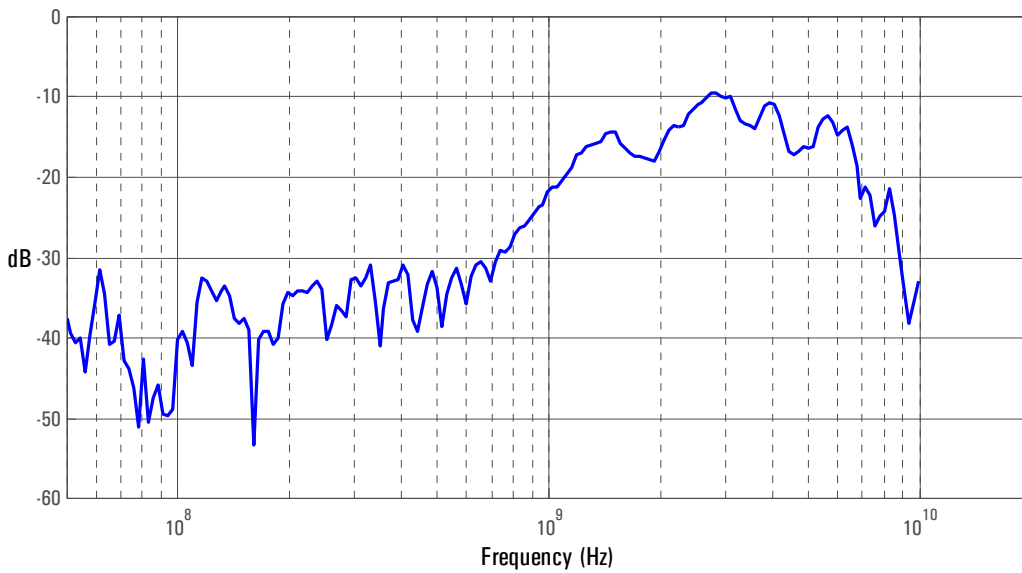

Graph of V_{out}/V_{in} frequency response when inputs driven in common (common mode rejection).

Figure 1-20

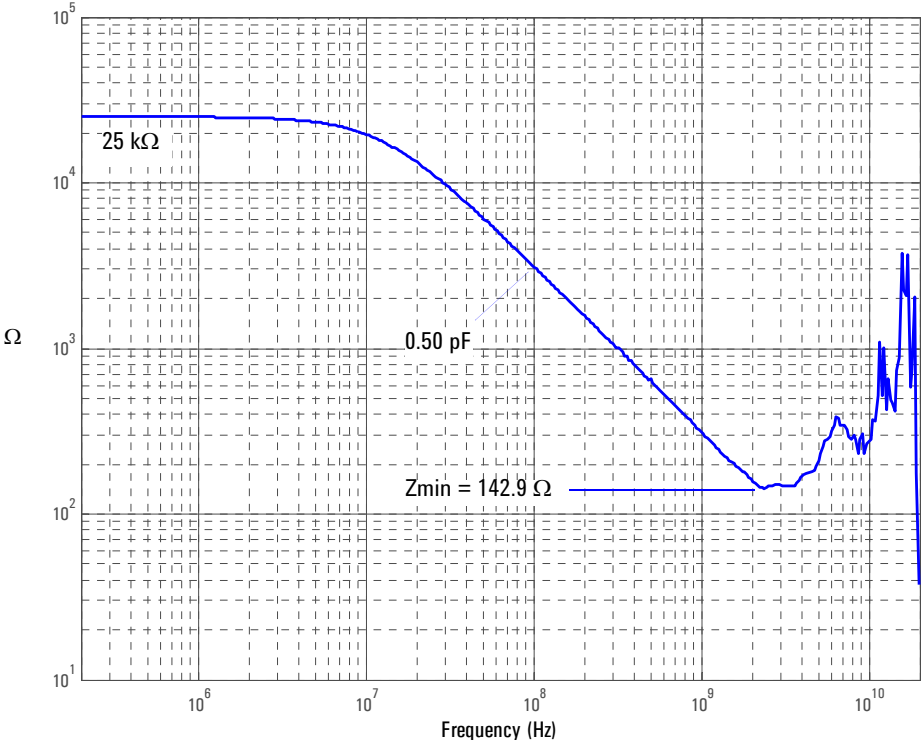

Magnitude plot of probe input impedance versus frequency.

5 Single-ended Browser

Figure 1-21

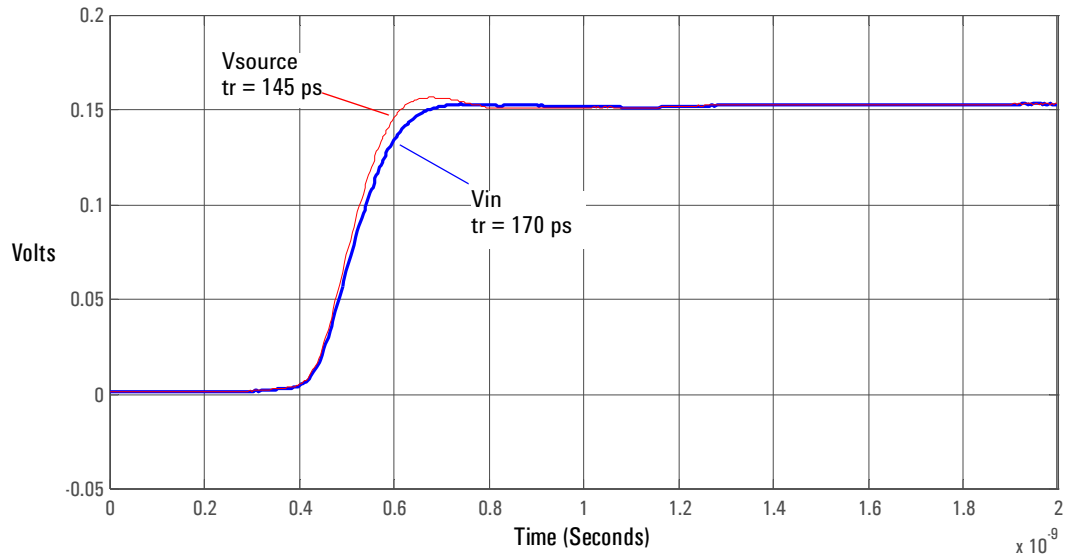

Graph of 25 Ω 100 ps step generator with and without probe connected.

Figure 1-22

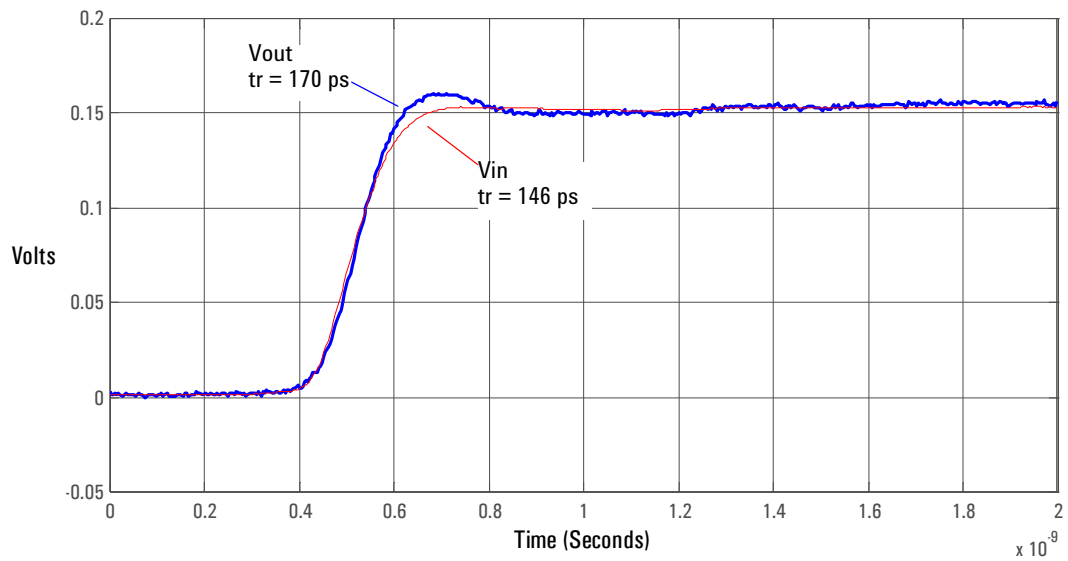

Graph of V_{in} and V_{out} of probe with a 25 Ω 100 ps step generator.

Figure 1-23

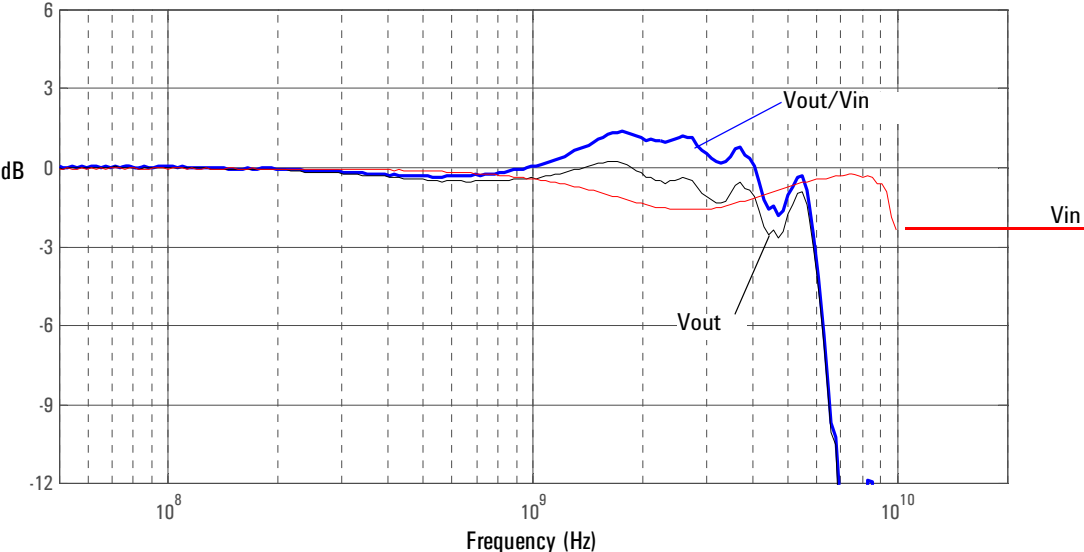

Graph of V_{in} and V_{out} of probe with a 25Ω source and V_{out}/V_{in} frequency response.

Figure 1-24

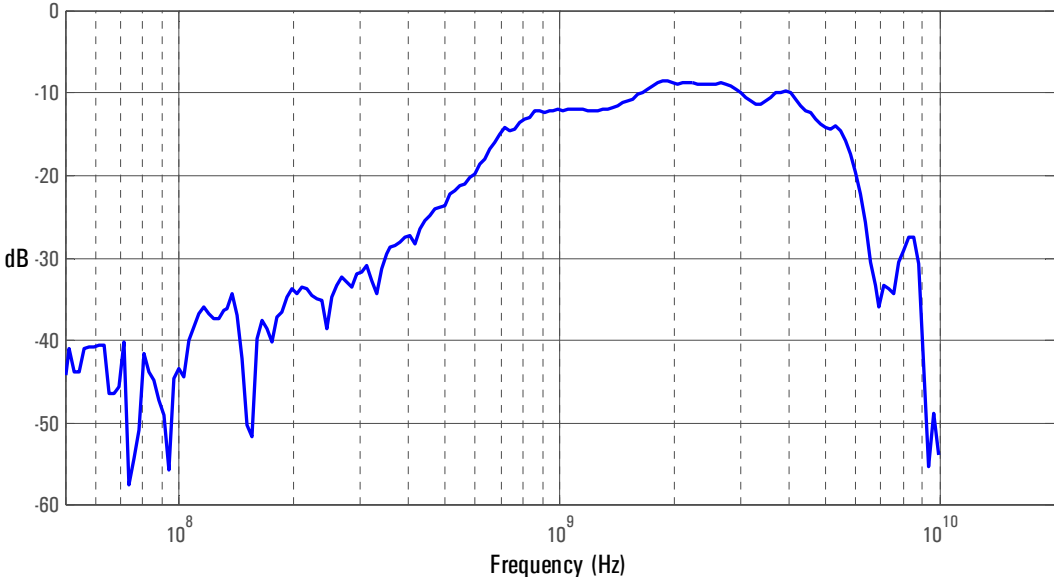

Graph of V_{out}/V_{in} frequency response when inputs driven in common (common mode rejection).

Differential and Single-ended Probe Configurations

5 Single-ended Browser

Figure 1-25

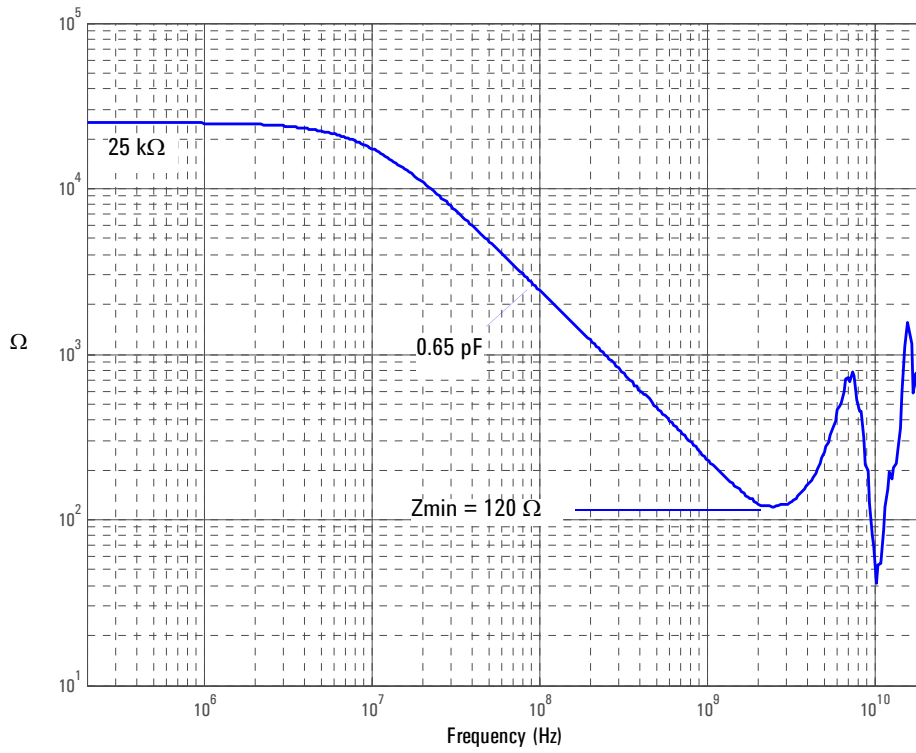

Magnitude plot of probe input impedance versus frequency.

6 Solder-in Differential Probe Head (Medium Bandwidth)

Figure 1-26

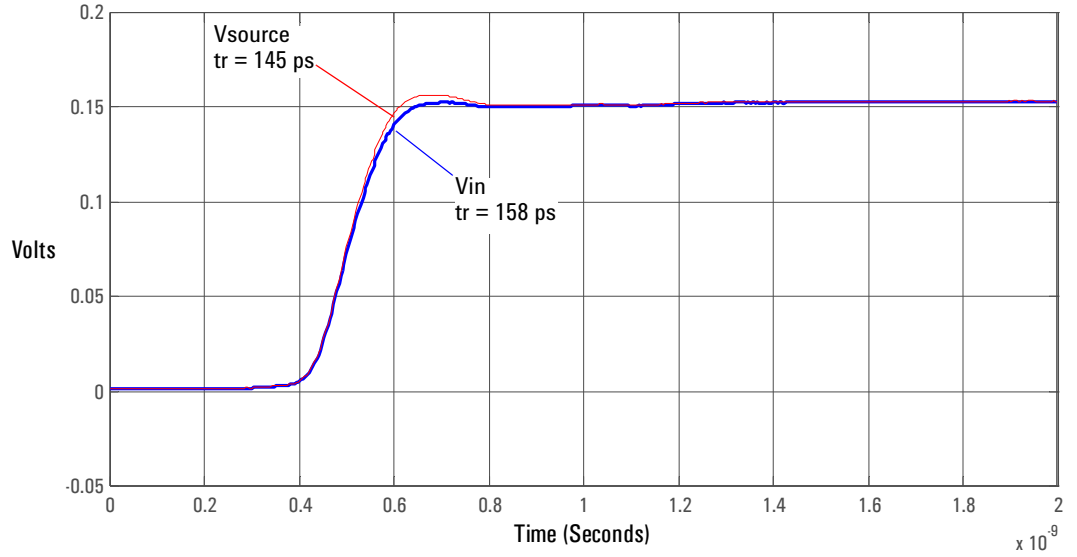

Graph of 25 Ω 100 ps step generator with and without probe connected.

Figure 1-27

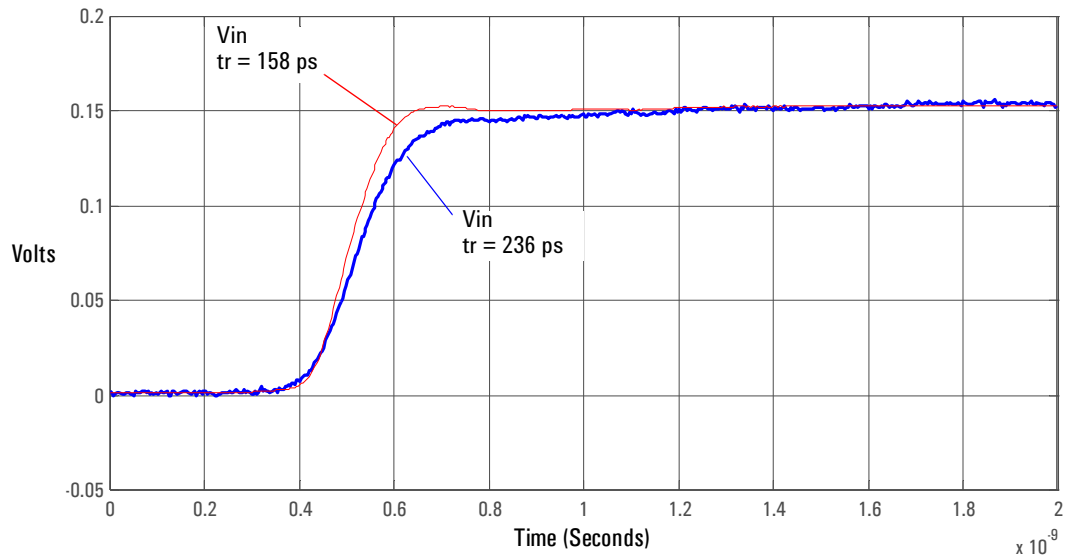

Graph of V_{in} and V_{out} of probe with a 25 Ω 100 ps step generator.

**Differential and Single-ended Probe Configurations
6 Solder-in Differential Probe Head (Medium Bandwidth)**

Figure 1-28

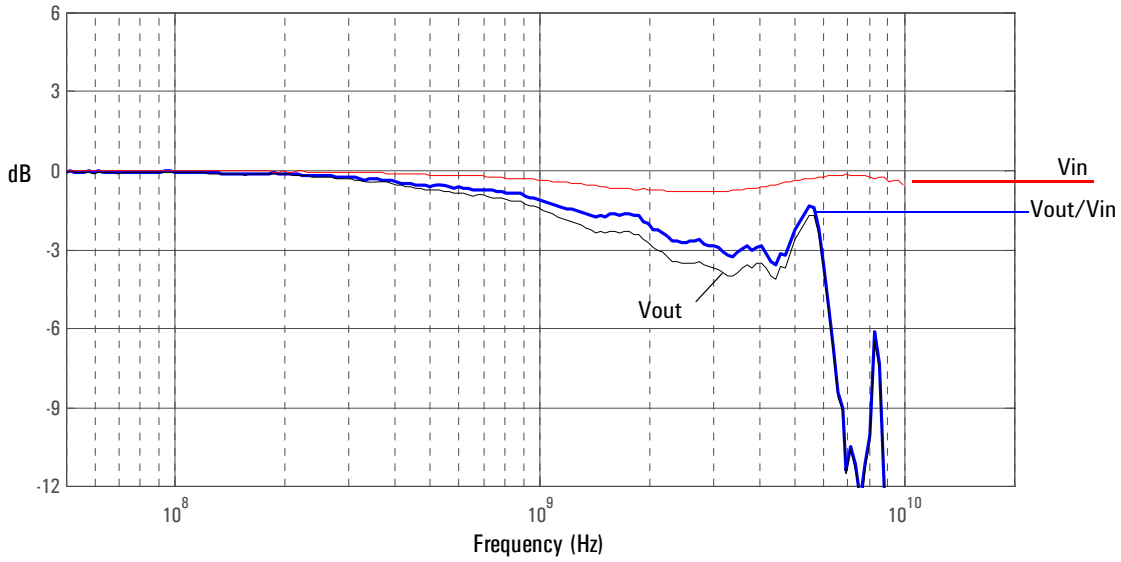

Graph of V_{in} and V_{out} of probe with a 25Ω source and V_{out}/V_{in} frequency response.

Figure 1-29

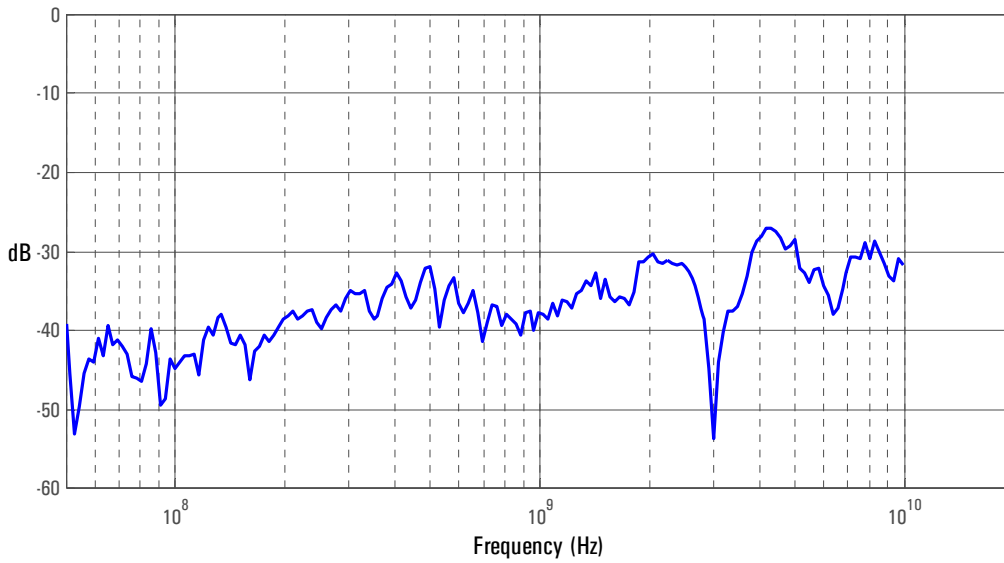

Graph of V_{out}/V_{in} frequency response when inputs driven in common (common mode rejection).

Figure 1-30

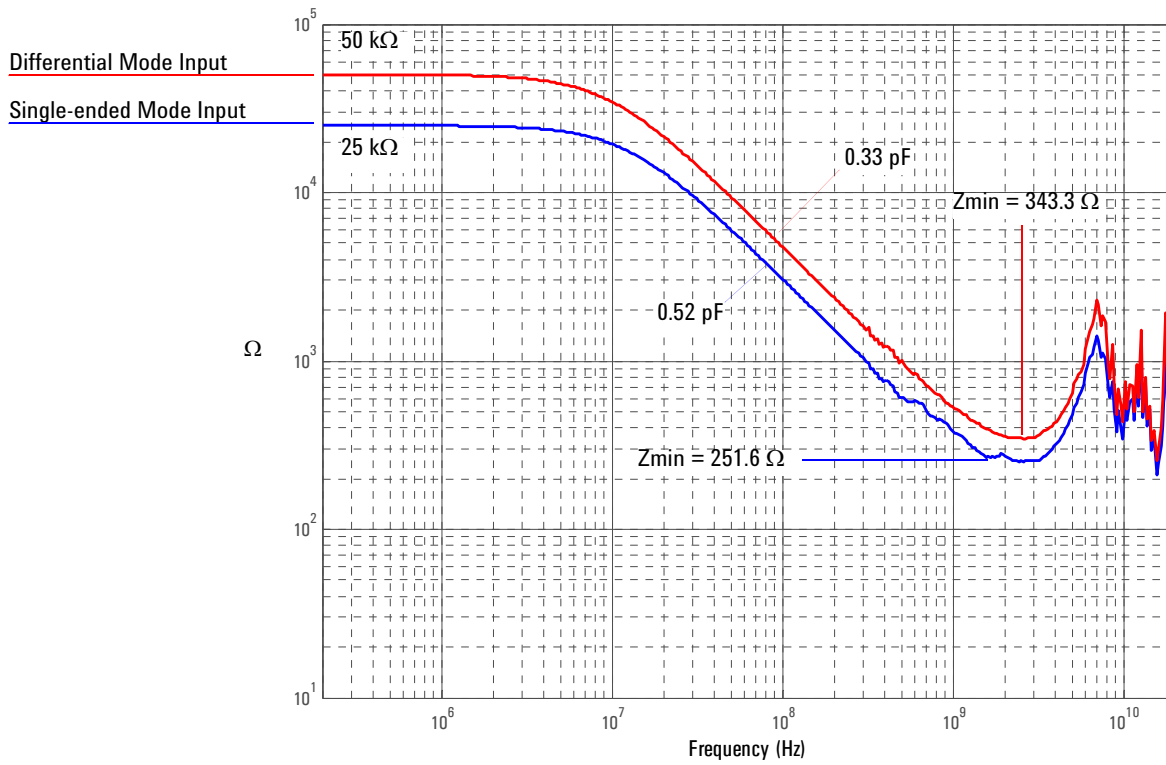

Magnitude plot of probe input impedance versus frequency.

7 Solder-in Single-ended Probe Head (Medium Bandwidth)

Figure 1-31

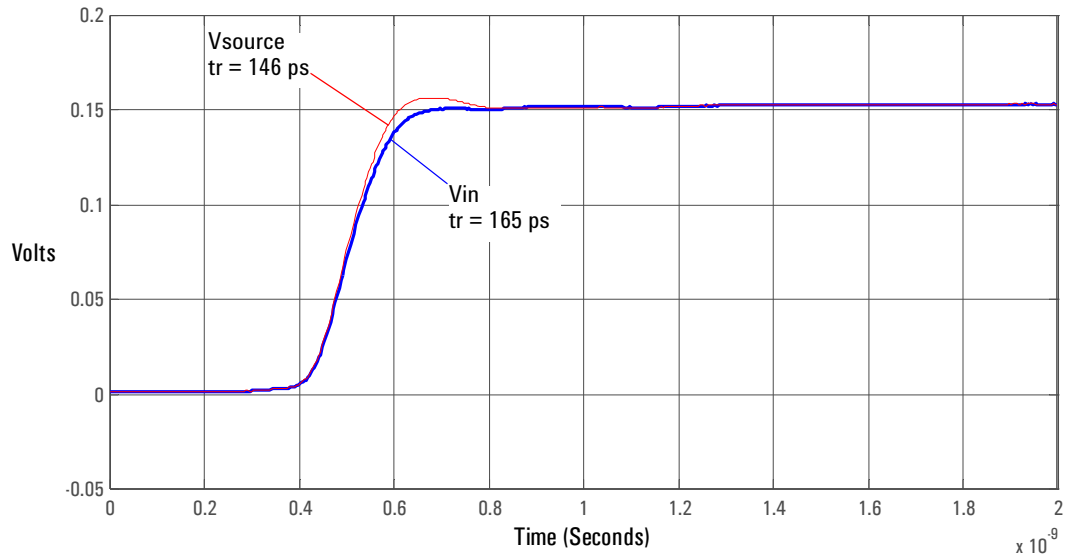

Graph of 25 Ω 100 ps step generator with and without probe connected.

Figure 1-32

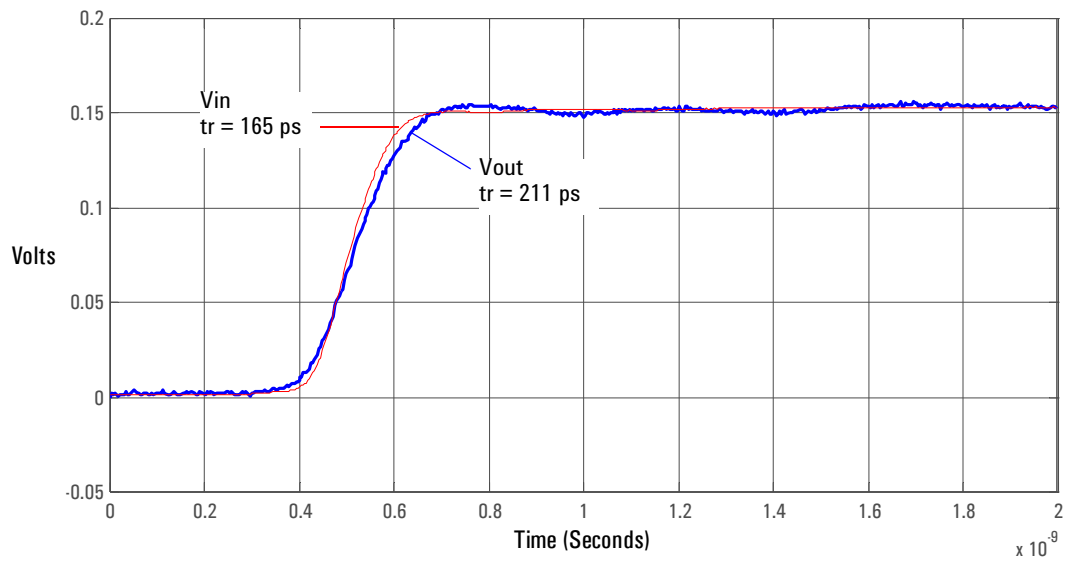

Graph of V_{in} and V_{out} of probe with a 25 Ω 100 ps step generator.

Figure 1-33

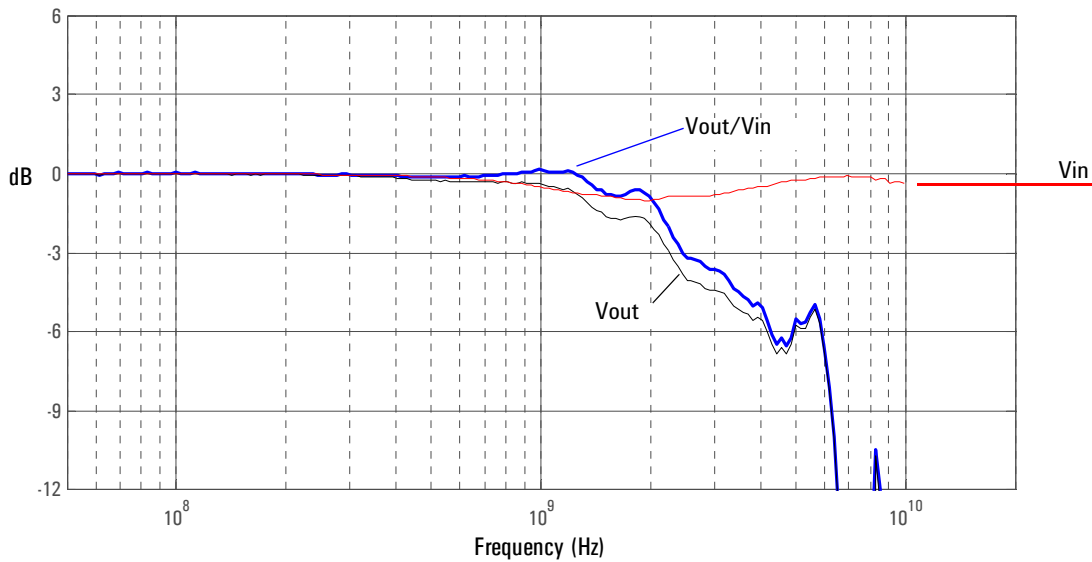

Graph of V_{in} and V_{out} of probe with a $25\ \Omega$ source and V_{out}/V_{in} frequency response.

Figure 1-34

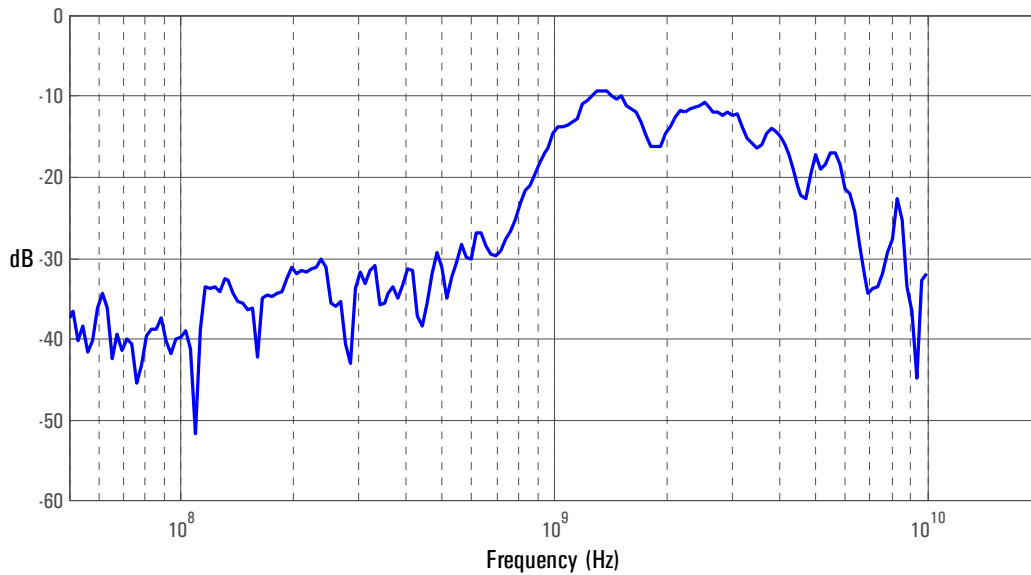

Graph of V_{out}/V_{in} frequency response when inputs driven in common (common mode rejection).

Differential and Single-ended Probe Configurations
7 Solder-in Single-ended Probe Head (Medium Bandwidth)

Figure 1-35

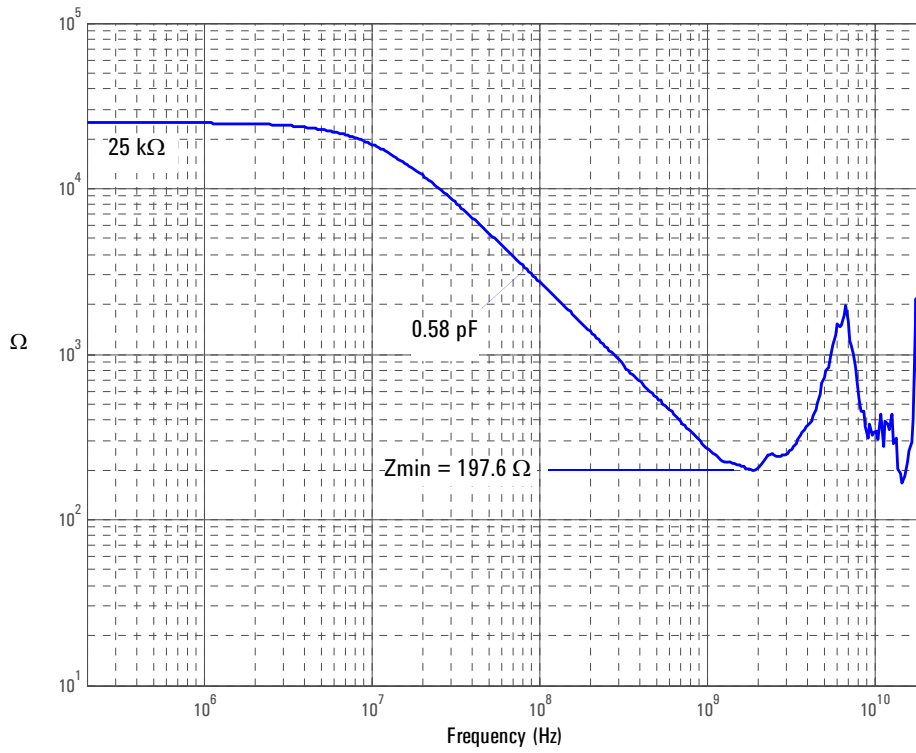

Magnitude plot of probe input impedance versus frequency.

8 Socketed Differential Probe Head with Damped Wire Accessory

Due to reflections on the long wire accessories, signals being probed should be limited to $\sim \geq 240$ ps rise time measured at the 10 % and 90 % amplitude levels. This is equivalent to $\sim \leq 1.5$ GHz bandwidth.

Figure 1-36

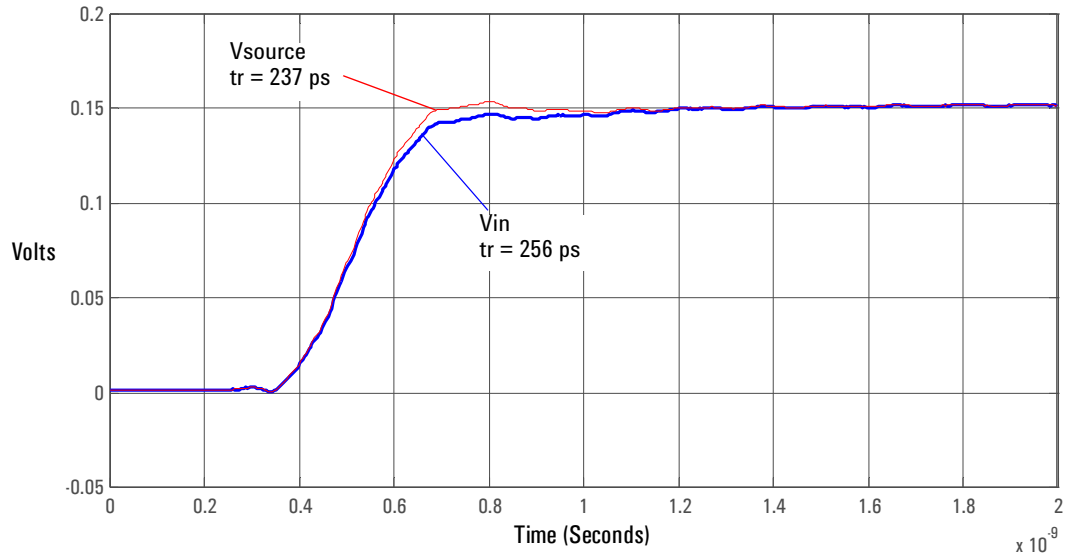

Graph of 25Ω 240 ps step generator with and without probe connected.

Figure 1-37

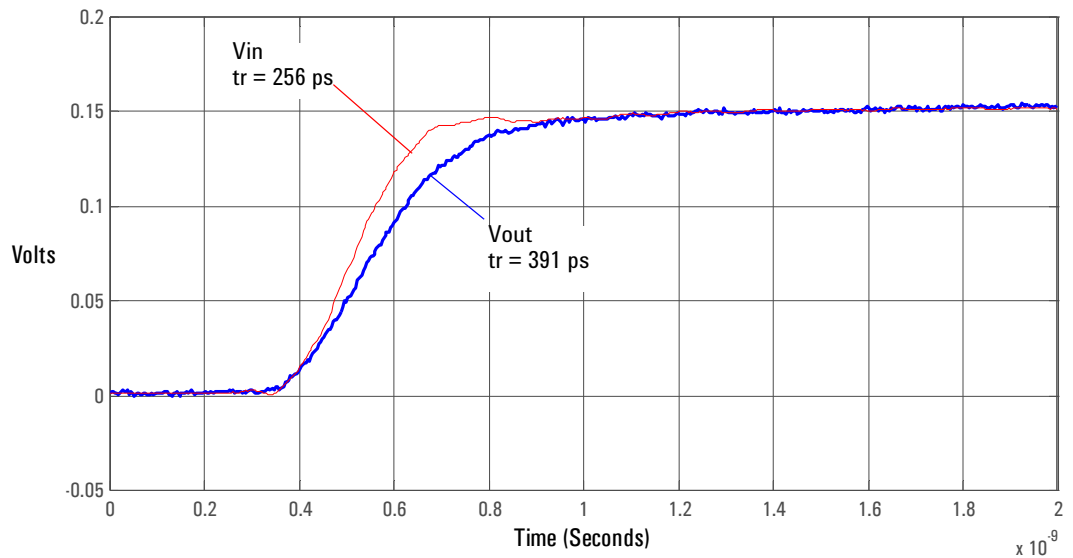

Graph of V_{in} and V_{out} of probe with a 25Ω 240 ps step generator.

Differential and Single-ended Probe Configurations
8 Socketed Differential Probe Head with Damped Wire Accessory

Figure 1-38

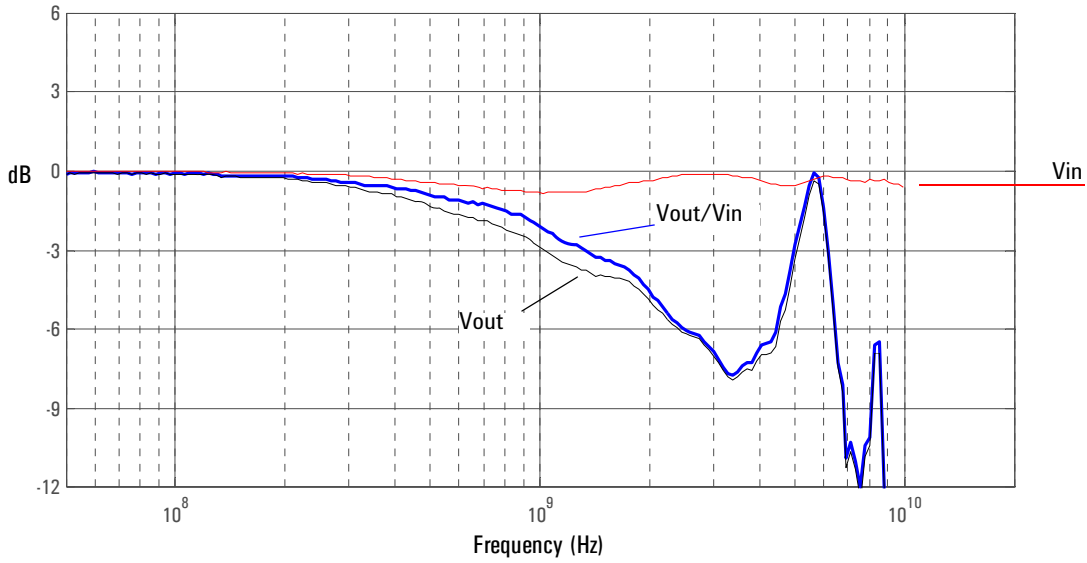

Graph of V_{in} and V_{out} of probe with a $25\ \Omega$ source and V_{out}/V_{in} frequency response.

Figure 1-39

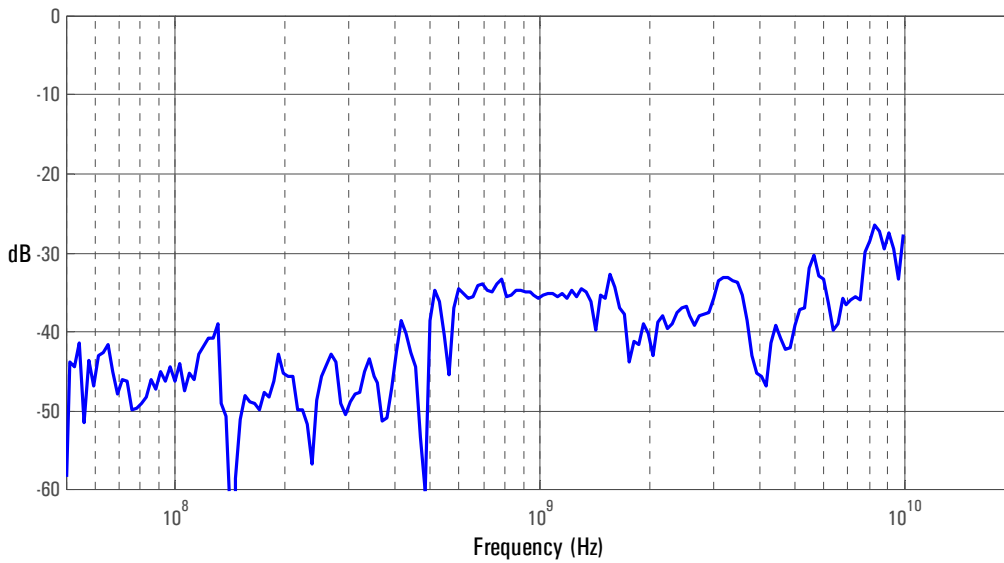

Graph of V_{out}/V_{in} frequency response when inputs driven in common (common mode rejection).

Figure 1-40

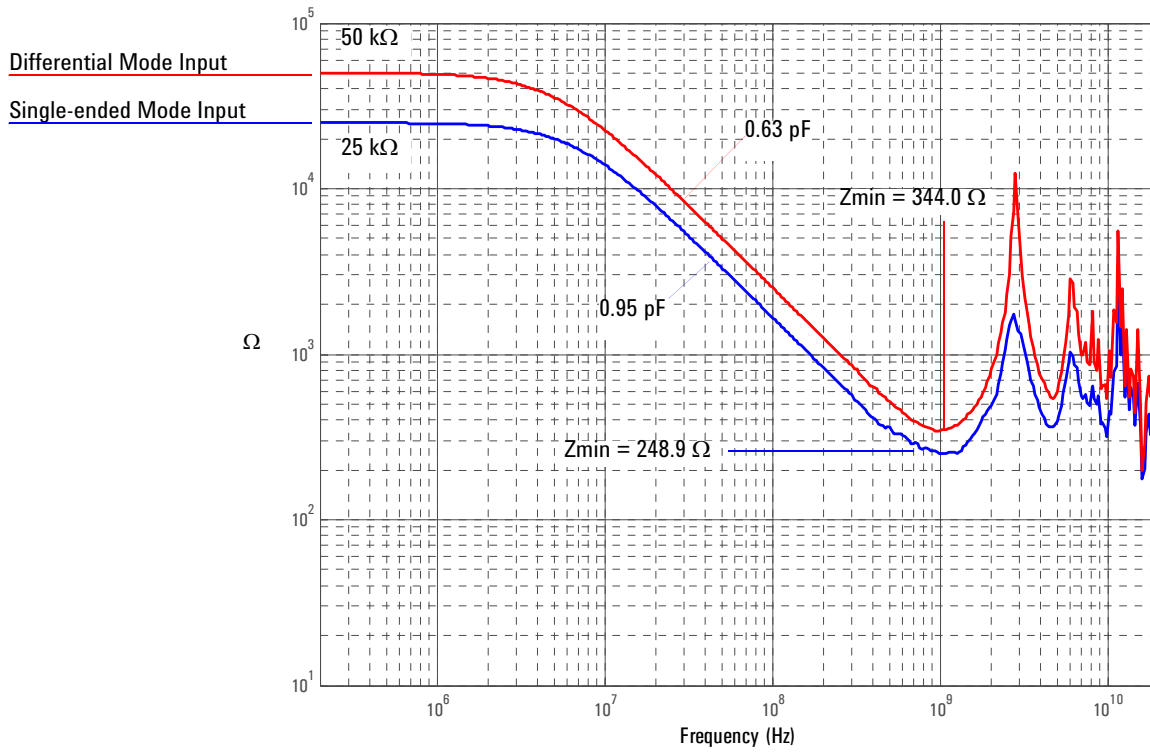

Magnitude plot of probe input impedance versus frequency.

Differential and Single-ended Probe Configurations
8 Socketed Differential Probe Head with Damped Wire Accessory

Service

Service

The service section of this manual contains the following information:

- Service Strategy for the 1132A probe
- Cleaning the 1132A probe
- Returning the 1132A probe to Agilent Technologies for service
- Recommended tools and test equipment
- Calibration Testing Procedures
 - To Test Bandwidth
- Performance test record
- Replaceable parts and accessories

Service Strategy for the 1132A Probe

This chapter provides service information for the 1132A family of Active and Differential Probes. The following sections are included in this chapter.

- Service strategy
- Returning to Agilent Technologies for service
- Troubleshooting
- Failure symptoms

The 1132A Active Probe is a high frequency device with many critical relationships between parts. For example, the frequency response of the amplifier on the hybrid is trimmed to match the output coaxial cable. As a result, to return the probe to optimum performance requires factory repair. If the probe is under warranty, normal warranty services apply.

There is one warranted specification which is listed below.

Table 2-1

Description	Specification	Further Information
Bandwidth	5 GHz	

You may perform the tests in the "Calibration and Operational Verification Tests" later in this chapter to ensure these specifications are met.

If the probe is found to be defective we recommend sending it to an authorized service center for all repair and calibration needs. Please see the "Returning to Agilent Technologies for Service" section later in this chapter.

Service
To return the probe to Agilent Technologies for service

To return the probe to Agilent Technologies for service

Follow the following steps before shipping the 1132A back to Agilent Technologies for service.

- 1** Contact your nearest Agilent sales office for information on obtaining an RMA number and return address.
- 2** Write the following information on a tag and attach it to the malfunctioning equipment.
Name and address of owner
Product model number Example 1132A
Product Serial Number Example MYXXXXXXXX
Description of failure or service required

Include probing and browsing tips if you feel the probe is not meeting performance specifications or a yearly calibration is requested.

- 3** Protect the 1132A Probe by wrapping in plastic or heavy paper.
- 4** Pack the 1132A Probe in the original carrying case or if not available use bubble wrap or packing peanuts.
- 5** Place securely in sealed shipping container and mark container as "FRAGILE".

If any correspondence is required, refer to the product by serial number and model number.

Troubleshooting

- If your probe is under warranty and requires repair, return it to Agilent Technologies. Contact your nearest Agilent Technologies Service Center.
- If the failed probe is not under warranty, you may exchange it for a reconditioned probe. See "To Prepare the Probe for Exchange" in this chapter.

Failure Symptoms

The following symptoms may indicate a problem with the probe or the way it is used. Possible remedies and repair strategies are included.

The most important troubleshooting technique is to try different combinations of equipment so you can isolate the problem to a specific probe.

Probe Calibration Fails

Probe calibration failure with an oscilloscope is usually caused by improper setup. If the calibration will not pass, check the following:

- Check that the probe passes a waveform with the correct amplitude.
- If the probe is powered by the oscilloscope, check that the offset is approximately correct. The probe calibration cannot correct major failures.
- Be sure the oscilloscope passes calibration without the probe.

Incorrect Pulse Response (flatness)

If the probe's pulse response shows a top that is not flat, check for the following:

- Output of probe must be terminated into a proper $50\ \Omega$ termination. If you are using the probe with an Infiniium oscilloscope, this should not be a problem. If you are using the probe with other test gear, insure the probe is terminated into a low reflectivity $50\ \Omega$ load ($\sim \pm 2\%$).
- If the coax or coaxes of the probe head in use has excessive damage, then reflections may be seen within $\sim 1\ \text{ns}$ of the input edge. If you suspect a probe head, swap it with another probe head and see if the non-flatness problem is fixed.
- If the one of the components in the tip have been damaged there may be a frequency gain non-flatness at around 40 MHz. If you suspect a probe head, swap it with another probe head and see if the non-flatness problem is fixed.

Incorrect Input Resistance

The input resistance is determined by the probe head in use. If the probe head is defective, damaged, or has been exposed to excessive voltage, the input resistor may be damaged. If this is the case, the probe head is no longer useful. A new probe head will need to be obtained either through purchase or warranty return.

Incorrect Offset

Assuming the probe head in use is properly functioning, incorrect offset may be caused by defect or damage to the probe amplifier or by lack of probe calibration with the oscilloscope.

Calibration Testing Procedures

These tests can be performed to ensure the 1132A Probe meets specifications.

Some tests require the probe to be calibrated on an Infiniium oscilloscope channel before testing performance.

To Test Bandwidth

This test ensures that the 1132A Probe meets its specified bandwidth.

1132A >5 GHz

Table 2-2

Equipment/Tool	Critical Specification	Model Number
Vector Network Analyzer (VNA)	5 GHz sweep range full 2 port cal Option 1D5	Agilent 8720ES
Calibration Standards	No Substitute	Agilent 85052D
External Power Supply	No Substitute	Agilent 1143A
AutoProbe Interface Adapter	No Substitute	Agilent N1022A
Outside thread 3.5 mm (male) to 3.5 mm (female) adapter	No Substitute	Agilent 5062-1247
Cable (2)	3.5 mil; SMA; High Quality	Agilent 8120-4948
Cable	1.5 mil Probe Power Extension No Substitute	Agilent 01143-61602
PV/DS Test Board	No Substitute (In E2655A Kit)	Agilent E2655-66501

Using the 8720ES VNA successfully

Remember these simple guidelines when working with the 8720ES VAN to get accurate stable measurements.

- 1 Sometimes it may take a few seconds for the waveforms to settle completely. Please allow time for waveforms to settle before continuing.
- 2 Make sure all connections are tight and secure. If needed, use a vice to hold the cables and test board stable while making measurements.
- 3 Be careful not to cross thread or force any connectors. This could be a very costly error to correct.

Initial Setup

- 1 Turn on the 8720ES VNA and let warm up for 20 minutes.
- 2 Press the green "Preset" key on the 8720ES VNA.
- 3 Use the 8720ES VNA's default power setting of 0 dBm. You can locate this feature by pressing the "Power" key on the front panel.
- 4 Set the 8720ES VNA's averaging to 4. You can find this selection menu by pressing the "AVG" key. Then select the "Averaging Factor" screen key to adjust the averaging.
- 5 Press the "Sweep Setup" key on the 8720ES VNA. Then press the "sweep type menu" screen key. Select the "log freq" screen key.
- 6 Connect the 1132A probe under test to the Auto Probe Adapter and power the probe using the 1143A power supply. Install the outside thread adapter to the Auto Probe Adapter.

Figure 2-1

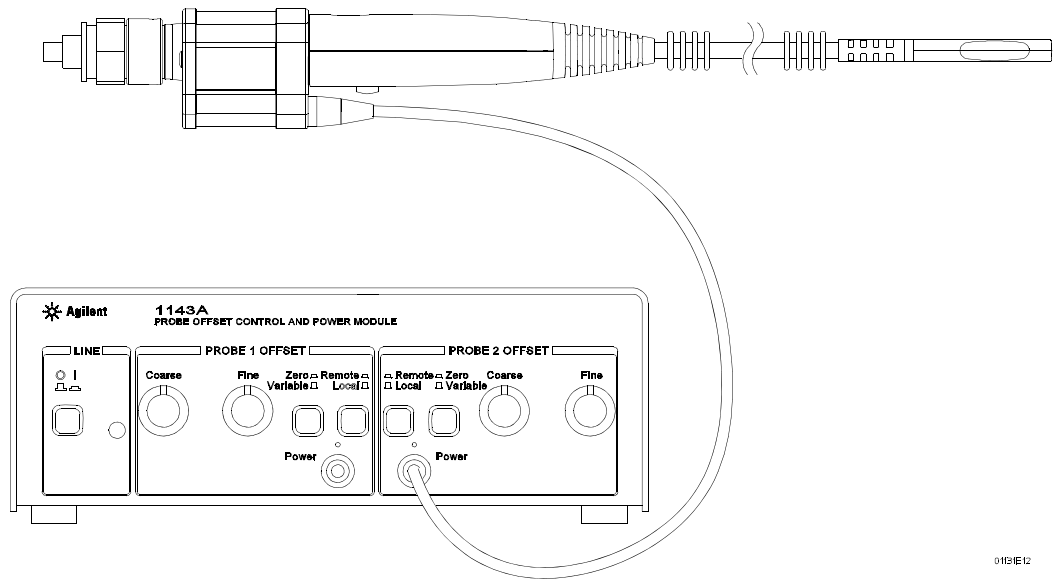

01B/E12

Calibrating a Reference Plane

To get a reliable measurement from the 8720ES VNA we must calibrate a reference plane so that the 8720ES VNA knows where the probe under test is located along the transmission line.

**Service
To Test Bandwidth**

- 1 Press the "Cal" key on the 8720ES VNA.

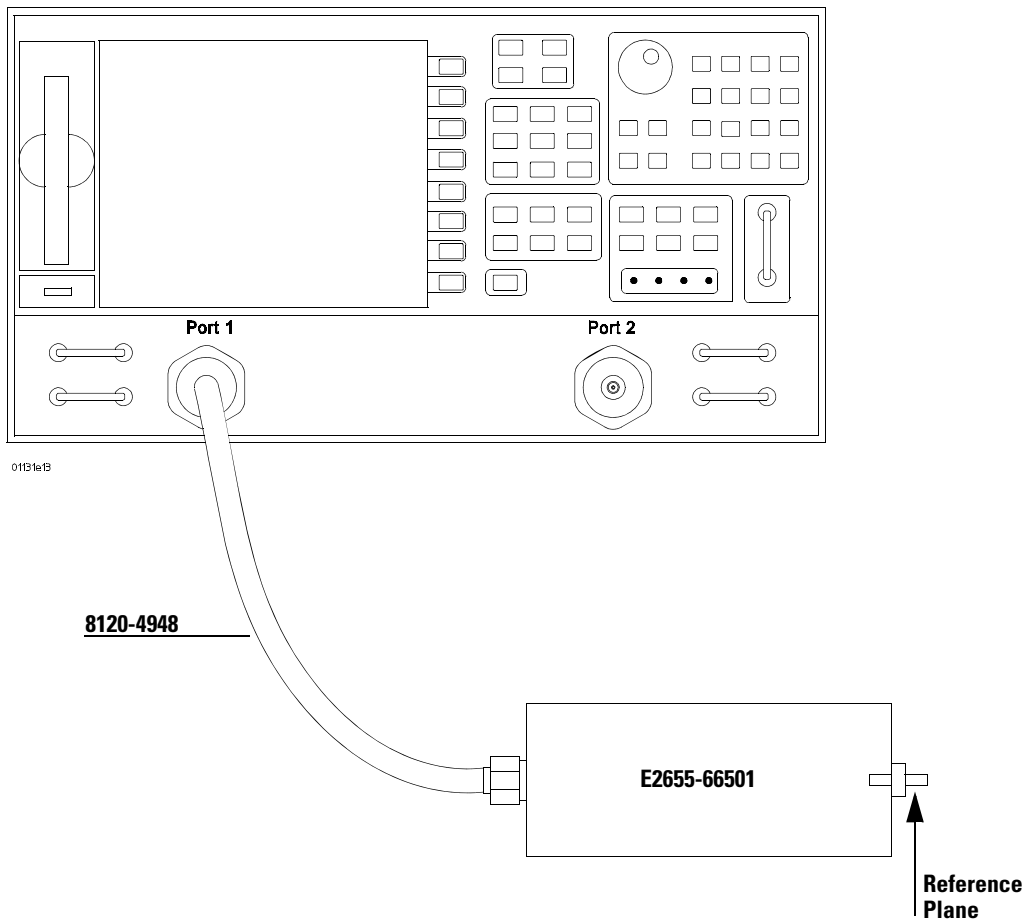

- 2 Then Press the "cal menu" screen key.
- 3 Finally, press the "full 2 port" screen key.
- 4 Connect one of the high quality SMA cables to port one and to the pincher side of PV/DS test board.
- 5 The calibration reference plane is at the other end of PV/DS test board.

Figure 2-2

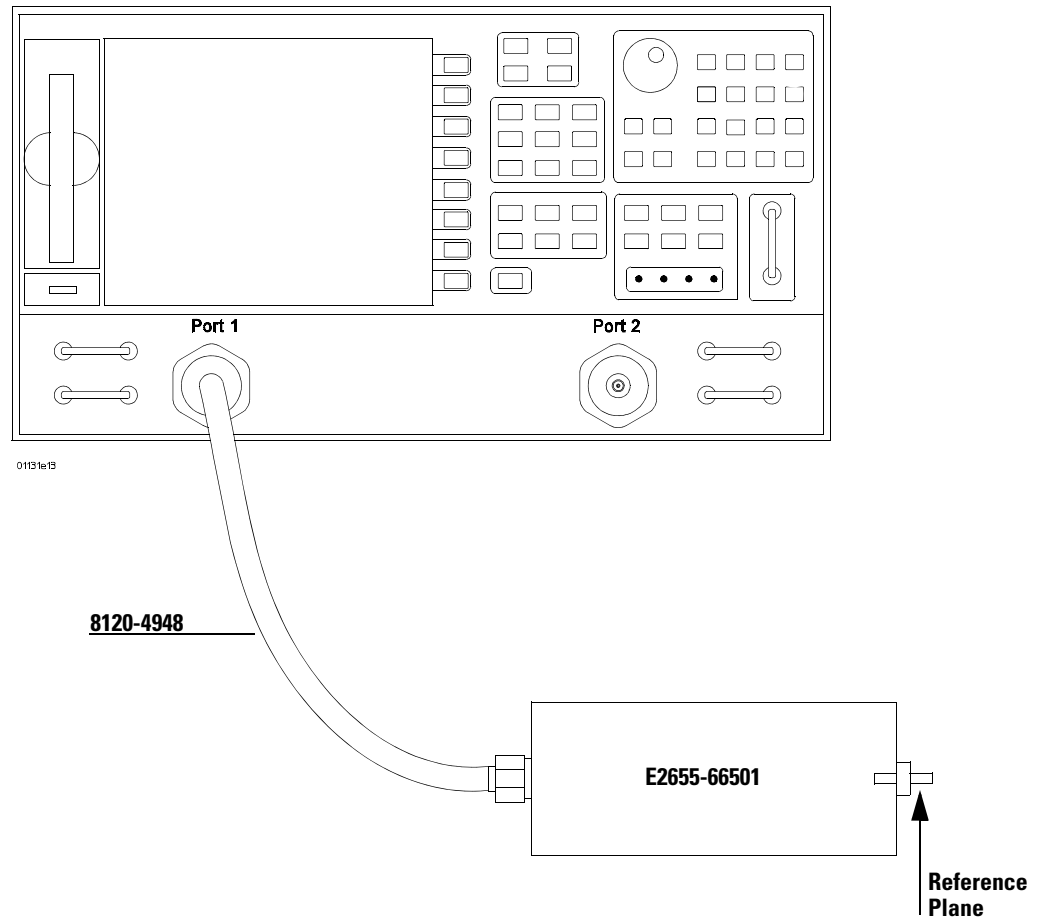

6 Perform Calibration for the port one side of the Reference plane.

- Press the "reflection" screen key
- Connect open end of 85052D to the non-pincher side of the PV/DS test board.
- Select the "open" screen key under the "Forward" group.
- The 8720ES VAN will beep when done.
- Connect short end of 85052D to the non-pincher side of the PV/DS test board.
- Select "short" screen key under the "Forward" group.
- The 8720ES VAN will beep when done.
- Connect load end of 85052D to the non-pincher side of the PV/DS test board.
- Select the "loads" screen key under the "Forward" group.
- Press "broadband" screen key selection.
- The 8720ES VAN will beep when done.
- Press the "done loads" screen key.
- You have just calibrated one side of the reference plane.

7 Connect the other high quality SMA cable to port two of the 8720ES VNA.

**Service
To Test Bandwidth**

Figure 2-3

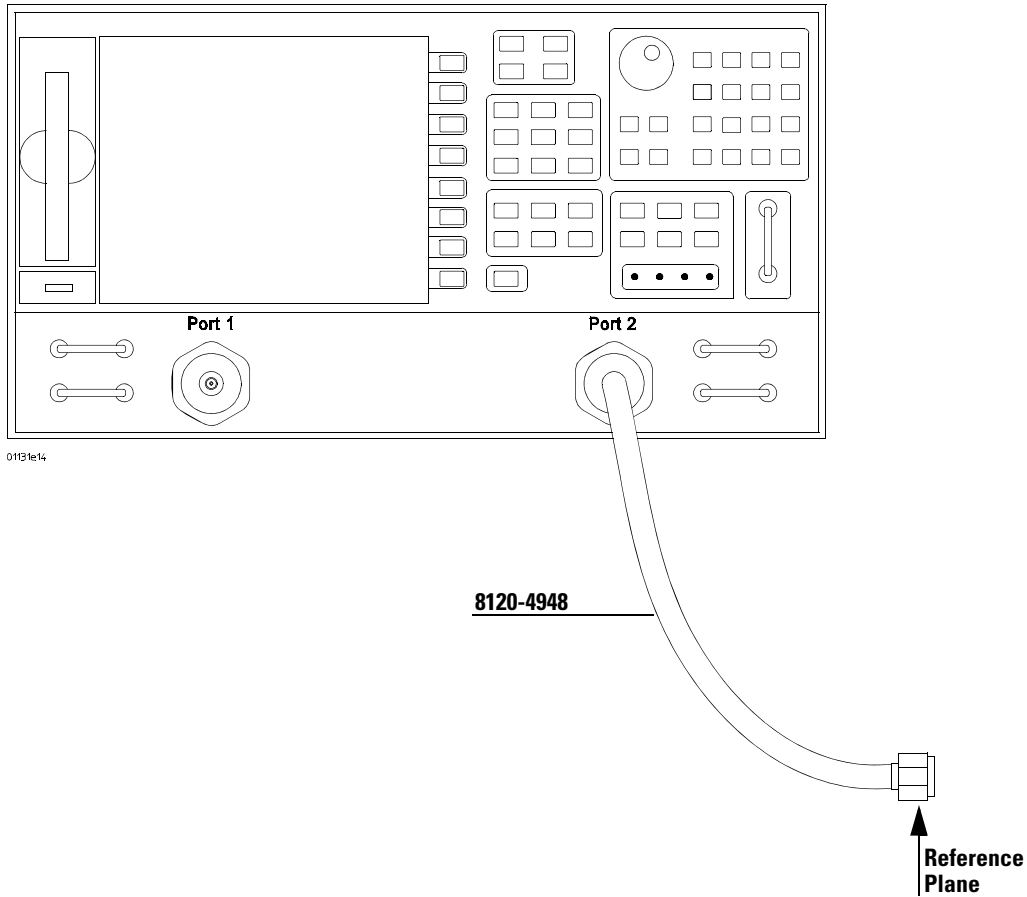

- 8** Get the opposite sex of the 85052D calibration standards for the next step.
- 9** Perform Calibration for the port two side of the Reference plane.
 - Press the "reflection" screen key.
 - Connect open end of 85052D to the available end of the port two SMA cable.
 - Select the "open" screen key under the "Reverse" group.
 - The 8720ES VNA will beep when done.
 - Connect short end of 85052D to the available end of the port two SMA cable.
 - Select "short" screen key the "Reverse" group.
 - The 8720ES VNA will beep when done.
 - Connect load end of 85052D to the available end of the port two SMA cable.
 - Select the "loads" screen key the "Reverse" group.
 - Press "broadband" screen key selection.
 - The 8720ES VNA will beep when done.
 - Press the "done loads" screen key.
 - You have just calibrated the other side of the reference plane.
- 10** Press "standards done" key.
- 11** Connect port two SMA cable to the non-pincher side of PV/DS test board.

Figure 2-4

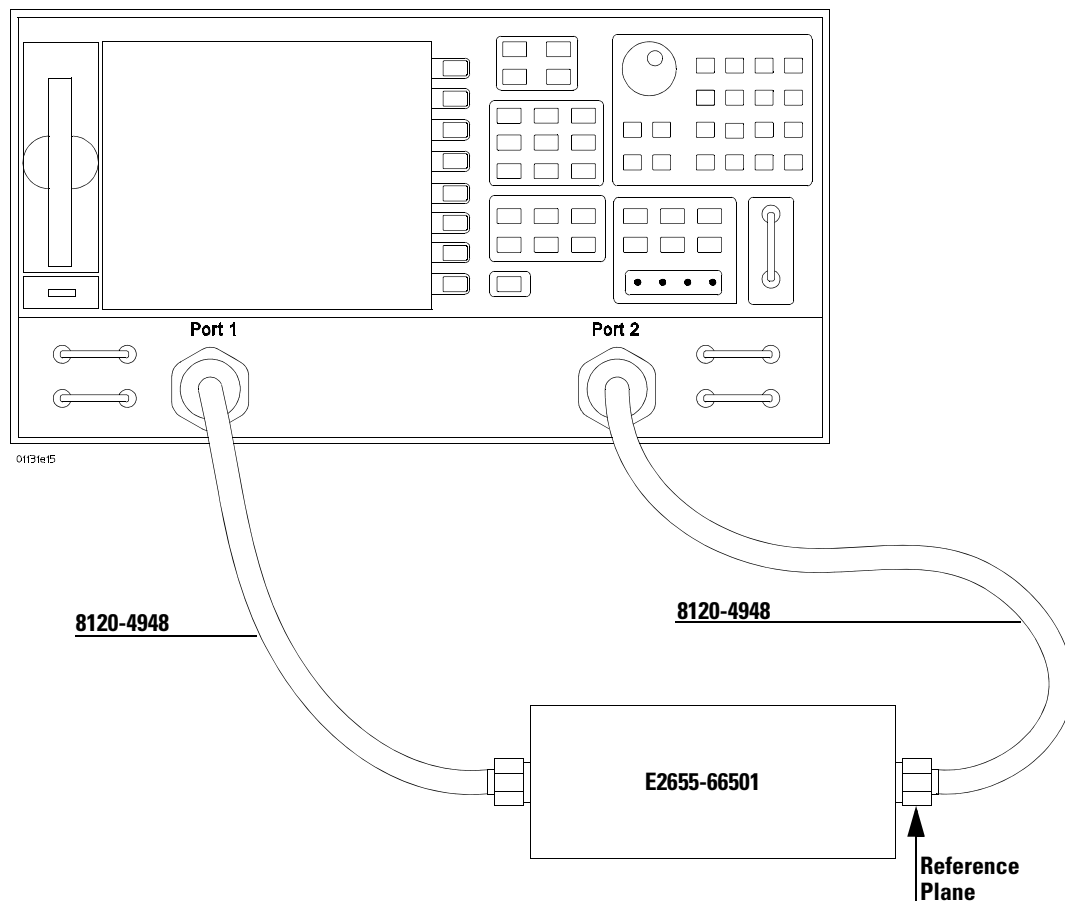

- 12 Press the "transmission" screen key.
- 13 Press the "do both fwd and reverse" screen key.
- 14 The 8720ES VNA will beep **four** times when done.
- 15 Press the "isolation" screen key.
- 16 Press the "omit isolation" screen key.
- 17 Press "done 2 port cal" screen key.
- 18 Set the 8720ES VNA's averaging to off.
- 19 Save the reference plane cal by pressing the "save recall" key then the "save state" key.
- 20 You may change name if you wish.
- 21 Press the "scale reference" key. Then
 - Set for 1 dB per division.
 - Set reference position for 7 divisions.
 - Set reference value for 0 dB
- 22 Press the "measure" key.
- 23 Press the "s21" screen key.
- 24 Ensure s21 response on screen is flat (about ± 0.1 dB) out to 10 GHz.

**Service
To Test Bandwidth**

Measuring Vin Response

- 1 Position 1132A probe conveniently to make quality connections on the PV/DS board.
- 2 Ensure resistors at the probe tip are reasonably straight and about 0.1 inches apart.
- 3 Connect probe tip under pincher on PV/DS board

Apply upward pressure to the clip to insure proper electrical connection.

Place the "+" side on center conductor and "-" side to ground.

Press the "Sweep Setup" key on the 8720ES VNA. Then press the "trigger menu" screen key. Select the "continuous" screen key.

- 4 You should now have the Vin waveform on screen. It should look similar to Figure 2-5.

Figure 2-5

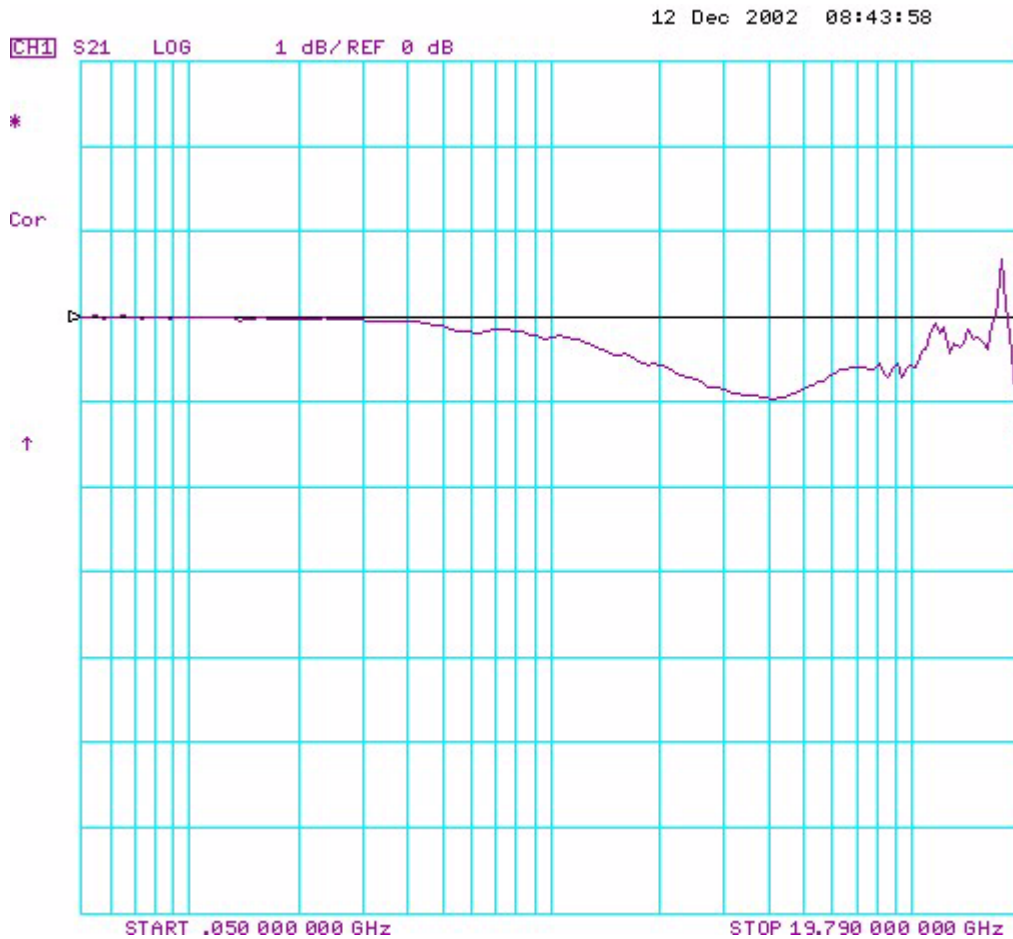

- 5 Select "display key" then "data->memory" screen key.
- 6 You have now saved Vin waveform into the 8720ES VNA's memory for future use.

Measuring Vout Response

- 1 Disconnect the port 2 cable from PV/DS test board and attach to probe output on the AutoProbe Adapter.
- 2 Connect the 85052D cal standard load to PV/DS test board (non-pincher side).
- 3 Press "scale reference" key on the 8720ES VNA.
- 4 Set reference value to -20 dB.
- 5 The display on screen is Vout. It should look similar to Figure 2-6.

Figure 2-6



Displaying Vin/Vout Response on 8720ES VNA Screen

- 1 Press the "Display" Key.
- 2 Then select the "Data/Memory" Screen Key. The display should look similar to Figure 2-7.
- 3 Press marker key and position the marker to the first point that the signal is below -3 dB.
- 4 Read marker frequency measurement and record it in the test record located later in this chapter.
- 5 The bandwidth test passes if the frequency measurement is greater than the probe's bandwidth limit. Example: > 5 GHz.

Service
To Test Bandwidth

Figure 2-7

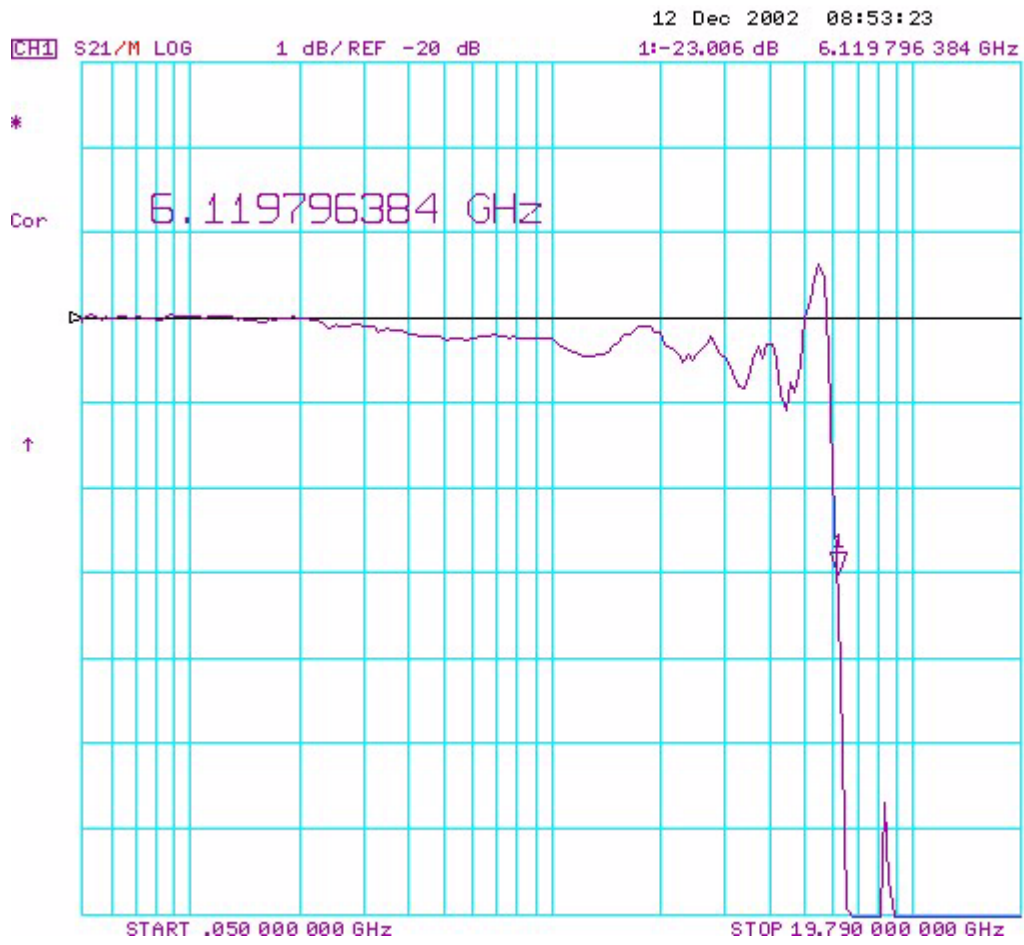

Performance Test Record

Test Name	Results	
Bandwidth	>5 GHz Result _____ GHz	Pass/Fail

Replaceable Parts and Accessories

See the "User's Quick Start Guide" for a list of replaceable parts and accessories.

Index

B

bandwidth test 2-8

C

calibration

failure 2-6

calibration procedure 2-7

cleaning the instrument 1-3

F

failure symptoms 2-6

I

instrument, cleaning the 1-3

P

packing for return 2-4

parts

replaceable 2-18

R

repair 2-4

replacement parts 2-18

returning probe to Agilent Technologies 2-4

S

service

strategy 2-3

specifications

warrantied 2-3

T

test

bandwidth 2-8

troubleshooting 2-5

Safety Notices

This apparatus has been designed and tested in accordance with IEC Publication 1010, Safety Requirements for Measuring Apparatus, and has been supplied in a safe condition. This is a Safety Class I instrument (provided with terminal for protective earthing). Before applying power, verify that the correct safety precautions are taken (see the following warnings). In addition, note the external markings on the instrument that are described under "Safety Symbols."

Warnings

- Before turning on the instrument, you must connect the protective earth terminal of the instrument to the protective conductor of the (mains) power cord. The mains plug shall only be inserted in a socket outlet provided with a protective earth contact. You must not negate the protective action by using an extension cord (power cable) without a protective conductor (grounding). Grounding one conductor of a two-conductor outlet is not sufficient protection.
- Only fuses with the required rated current, voltage, and specified type (normal blow, time delay, etc.) should be used. Do not use repaired fuses or short-circuited fuseholders. To do so could cause a shock or fire hazard.
- If you energize this instrument by an auto transformer (for voltage reduction or mains isolation), the common terminal must be connected to the earth terminal of the power source.
- Whenever it is likely that the ground protection is impaired,

you must make the instrument inoperative and secure it against any unintended operation.

- Service instructions are for trained service personnel. To avoid dangerous electric shock, do not perform any service unless qualified to do so. Do not attempt internal service or adjustment unless another person, capable of rendering first aid and resuscitation, is present.
- Do not install substitute parts or perform any unauthorized modification to the instrument.
- Capacitors inside the instrument may retain a charge even if the instrument is disconnected from its source of supply.
- Do not operate the instrument in the presence of flammable gasses or fumes. Operation of any electrical instrument in such an environment constitutes a definite safety hazard.
- Do not use the instrument in a manner not specified by the manufacturer.

To clean the instrument

If the instrument requires cleaning: (1) Remove power from the instrument. (2) Clean the external surfaces of the instrument with a soft cloth dampened with a mixture of mild detergent and water. (3) Make sure that the instrument is completely dry before reconnecting it to a power source.

Safety Symbols



Instruction manual symbol: the product is marked with this symbol when it is necessary for you to refer to the instruction manual in order to protect against damage to the product..



Hazardous voltage symbol.



Earth terminal symbol: Used to indicate a circuit common connected to grounded chassis.

Notices

© Agilent Technologies, Inc. 2009

No part of this manual may be reproduced in any form or by any means (including electronic storage and retrieval or translation into a foreign language) without prior agreement and written consent from Agilent Technologies, Inc. as governed by United States and international copyright laws.

Manual Part Number

01132-97005, October 2009

Print History

01132-97000, January 2003

01132-97001, June 2003

01132-97002, September 2003

01132-97003, May 2004

01132-97004, October 2008

01132-97005, May 2009

Agilent Technologies, Inc.
1900 Garden of the Gods Road
Colorado Springs, CO 80907 USA

Restricted Rights Legend

If software is for use in the performance of a U.S. Government prime contract or subcontract, Software is delivered and licensed as "Commercial computer software" as defined in DFAR 252.227-7014 (June 1995), or as a "commercial item" as defined in FAR 2.101(a) or as "Restricted computer software" as defined in FAR 52.227-19 (June 1987) or any equivalent agency regulation or contract clause. Use, duplication or disclosure of Software is subject to Agilent Technologies' standard commercial license terms, and non-DOD Departments and Agencies of the U.S. Government will receive no greater than Restricted Rights as defined in FAR 52.227-19(c)(1-2) (June 1987). U.S. Government users will receive no greater than Lim-

ited Rights as defined in FAR 52.227-14 (June 1987) or DFAR 252.227-7015 (b)(2) (November 1995), as applicable in any technical data.

Document Warranty

The material contained in this document is provided "as is," and is subject to being changed, without notice, in future editions. Further, to the maximum extent permitted by applicable law, Agilent disclaims all warranties, either express or implied, with regard to this manual and any information contained herein, including but not limited to the implied warranties of merchantability and fitness for a particular purpose. Agilent shall not be liable for errors or for incidental or consequential damages in connection with the furnishing, use, or performance of this document or of any information contained herein. Should Agilent and the user have a separate written agreement with warranty terms covering the material in this document that conflict with these terms, the warranty terms in the separate agreement shall control.

Technology Licenses

The hardware and/or software described in this document are furnished under a license and may be used or copied only in accordance with the terms of such license.

WARNING

A WARNING notice denotes a hazard. It calls attention to an operating procedure, practice, or the like that, if not correctly performed or adhered to, could result in personal injury or death. Do not proceed beyond a WARNING notice until the indicated conditions are fully understood and met.

CAUTION

A CAUTION notice denotes a hazard. It calls attention to an operating procedure, practice, or the like that, if not correctly performed or adhered to, could result in damage to the product or loss of important data. Do not proceed beyond a CAUTION notice until the indicated conditions are fully understood and met.